

orfesa

Catálogo 2024

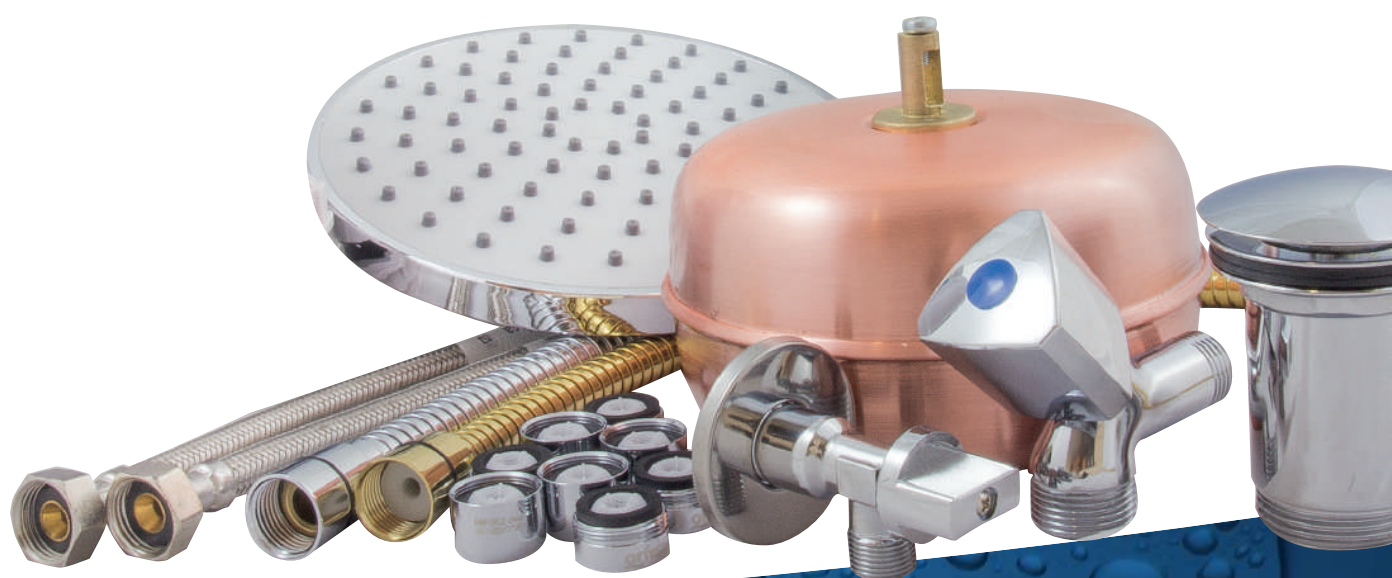

ÍNDICE

AHORRO DE AGUA

- 12 Aireadores
- 13 Estabilizadores
- 15 Mangos
- 16 Flexos
- 16 Rociadores
- 17 Aireadores cocina
- 18 Descargas W.C.
- 20 Grifos de llenado W.C.

BAÑO

- 22 Mangos
- 28 Flexos
- 32 Aireadores - Estabilizadores
- 34 Rociadores ducha
- 36 Brazos ducha
- 37 Soportes
- 39 Barras de ducha
- 40 Asideros - Barras cortinas de baño
- 41 Conjuntos - KITS
- 44 Higiénicos
- 46 Asientos y tapas W.C / Accesorios

COCINA

- 49 Mangos
- 50 Flexos
- 51 Rociadores

FONTANERÍA

- 53 Grifos
- 60 Conexiones
- 65 Boyas
- 66 Flotadores
- 67 Válvulas y sifones / Válvulas desagüe
- 68 Sifones PVC
- 69 Tubo alargado
- 70 Sifones metálicos
- 71 Válvulas clic-clac
- 72 Tapones
- 74 Rejillas
- 75 Tornillos
- 76 Accesorios cisterna
- 79 Accesorios lavavajillas
- 80 Accesorios fontanería / calefacción
- 83 Juntas
- 87 PTFE
- 88 Adhesivos y masillas
- 89 Accesorios de reparación
- 90 Racorería

PELUQUERÍA

- 96 Monomandos, mezcladores
- 97 Mangos / Soportes
- 98 Flexos
- 102 Válvulas
- 103 Accesorios

GRIFERÍA INDUSTRIAL

- 105 Duchas prelavado
- 109 Grifería
- 113 Accesorios

HISTORIA

Orfesa nació en 1949 como fabricantes de flexos, conexiones y boyas que con los años, acabó por convertirse en un proveedor especializado en componentes de calidad para los fabricantes de grifería de las primeras marcas a nivel mundial y del sector del saneamiento en general.

Actualmente, presentes en más de 30 países ocupando un puesto relevante en su sector inicial y en el ahorro de agua, esforzándose continuamente para contribuir con los productos a un consumo lógico y sostenible de este bien vital y escaso que es el agua. Caracterizándose por una continua búsqueda de la satisfacción

de los clientes, aportando soluciones innovadoras, manteniendo un alto nivel de calidad de suministros y ampliando el catálogo de productos continuamente.

Orfesa es una empresa dinámica con un equipo humano enfocado a la satisfacción del cliente y motivado hacia la mejora continua en todos los procesos claves de su actividad.

PRESENCIA EN EL MUNDO



1949



2005



1986



1992



2014

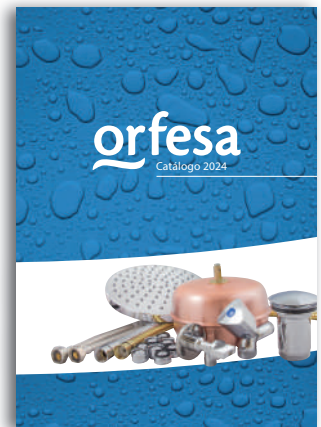

2024



BARCELONA - SPAIN



Tel: +34 934 742 561
Fax: +34 933 772 297



Whatsapp:
+34 934 742 561



orfesa@orfesa.net
www.orfesa.net

SOLUCIONES PARA EL AHORRO DE AGUA

Desde 2005, Orfesa se ha especializado en productos para el ahorro de agua llevándolos al sector de la ferretería y del bricolaje. Ofreciendo una amplia gama para el ahorro de agua en el hogar, aportando soluciones para ahorrar dentro de casa.

Coincidiendo con etapas de sequía en nuestro país, Orfesa se ha especializado en productos para el ahorro de agua desarrollando una gama de aireadores, estabilizadores de caudal para cocina y baño (grifos, flexos, mangos de ducha, etc) y mecanismos de descarga de cisternas W.C. graduables, aplicables tanto en el uso domestico como para colectividades, hospitales residencias. Desarrollando también embalajes adecuados para campañas de concienciación en el ahorro de agua ejecutadas por ayuntamientos , comunidades y otros organismos.



Comprometidos con la salud y la sostenibilidad



Nos comprometemos a destinar un porcentaje de las ganancias al programas de acceso al agua potable que Intermon Oxfam tiene abiertos en diferentes países.

Intermón Oxfam destina los ingresos a los programas de agua: potabilización, depósitos y canalizaciones de agua, construcción y rehabilitación de pozos. Actualmente trabaja en 15 proyectos junto con 10 organizaciones locales para construir las infraestructuras necesarias que lleven el agua potable en las zonas más desprotegidas y vulnerables, en países como Etiopía, Chad, Mozambique, Ecuador y Paraguay.

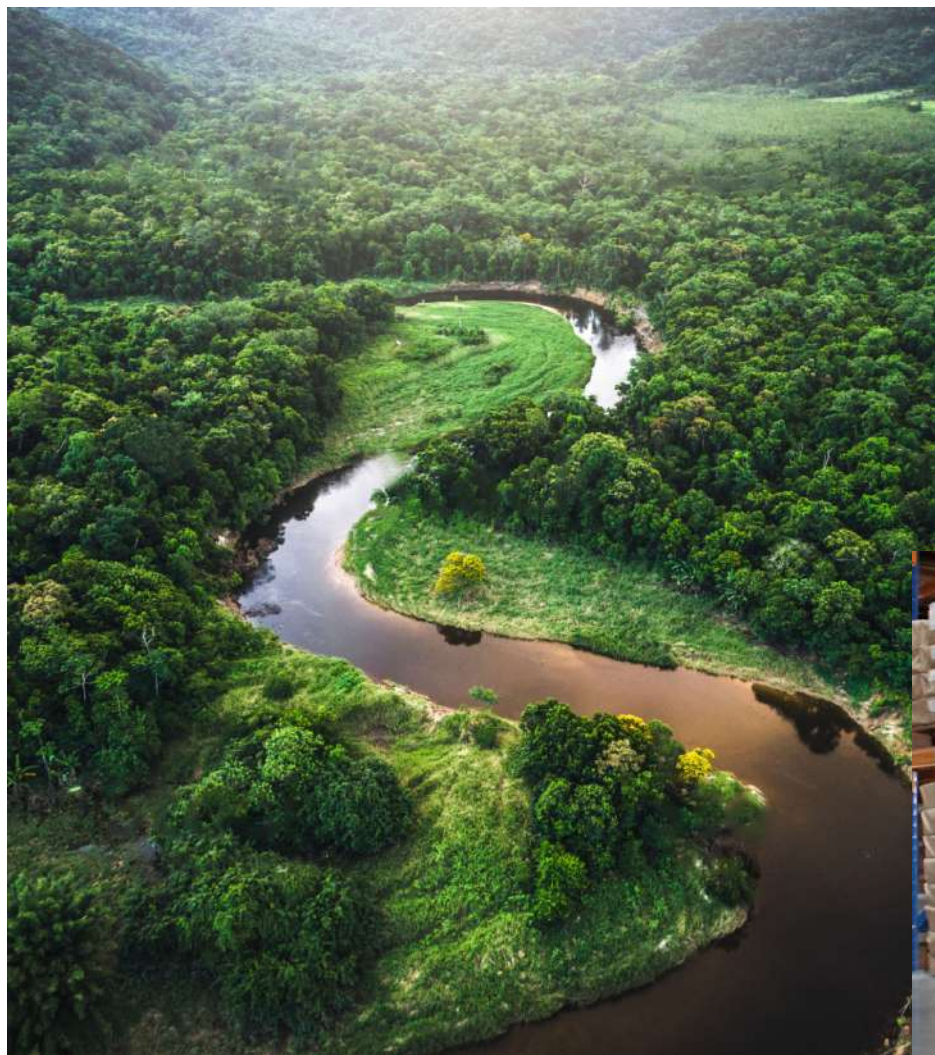

DESARROLLO DE PRODUCTOS

ORFESA le ayuda a desarrollar sus productos.

En otras palabras, creamos productos para usted.

Diseñamos, desarrollamos y probamos prototipos con las máximas exigencias normativas para convertirlos en soluciones flexibles satisfactorias.

En nuestras propias instalaciones, se prueban los límites de presión, temperaturas de funcionamiento,

medidas del caudal, resistencia a la tracción, etc., de los nuevos materiales y las nuevas capacidades. No dude en ponerse en contacto con nosotros. Esperamos poder ayudarle con nuestra experiencia y conocimientos técnicos.

Nuestra experiencia en conectores flexibles nos permite tener un conocimiento para el desarrollo de soluciones y requisitos específicos de la industria.

Contamos con un equipo de fabricación dedicado exclusivamente a soluciones específicas que reducirán los riesgos de diseño y desarrollo y acortarán el plazo de comercialización para su empresa.

ROCIADORES DE DUCHA

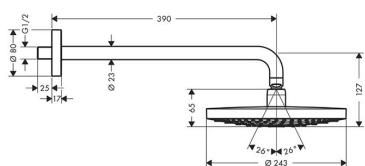

MANGOS DE DUCHA

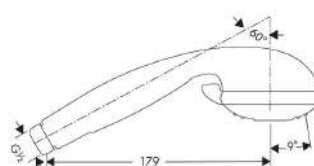

BOYAS

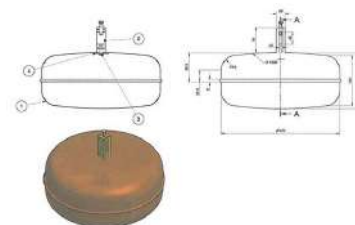

MANGOS PELUQUERÍA

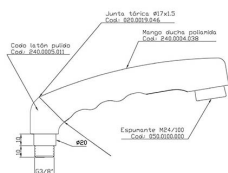

CONEXIONES

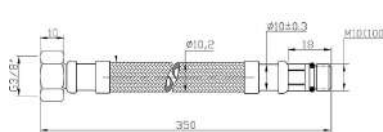

FLEXOS

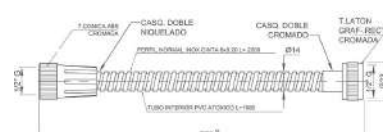

I+D+I

Orfesa ha ido capacitándose y modernizándose, incorporando nuevas tecnologías. Fabricando con materiales resistentes a la agresión del calcáreo, Desarrollando sistemas de fácil instalación de los productos. Integrando sistemas para la logística integral y la gestión de la cadena de suministro.

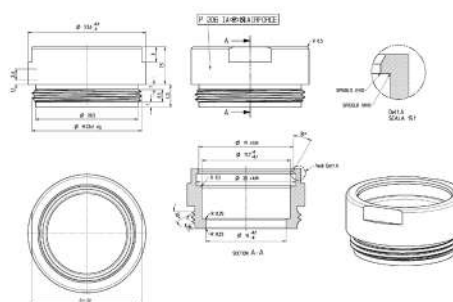

CERTIFICACIONES Y HOMOLOGACIONES



ACS Attestation de Conformité Sanitaire. Autorización oficial de la Dirección General de la Salud. Se aplica a todos los materiales en contacto con el agua destinada al consumo humano, expedida en Francia.



AENOR Asociación Española de Normalización y Certificación.

kiwa



KIWA Certificación y Homologación de Producto Holandesa.

Geprüfte Sicherheit Certificación de Producto Alemana.

K.T.W



KTW Empresa de Certificación de Producto Alemana para Aplicación de producto conductor de agua potable.

NSF Certificación de Producto en los Estados Unidos.



NF Certificación de Producto en Francia.



GARANTÍA DE CALIDAD AMBIENTAL Certificación de Etiquetado Ecológico Catalán.



APPLUS Laboratorio Europeo de Ensayo & Certificación.

Applus®

WATERMARK Certificación para productos de fontanería y drenaje para garantizar que son aptos para el propósito y están debidamente autorizados para su uso.



Calidad - Flexos

| | | Latón | Inoxidable cromado | PVC |
|----------------------------|---------------------------------|-------|--------------------|-----|
| Superficies | EN248 | • | • | - |
| Caudal | 25,2L/min - 3 ± 0,2 bar | • | • | • |
| Presión dinámica | 0,5 - bar | • | • | • |
| Resistencia a la tracción | F ≥500N | • | • | • |
| Resistencia a la flexión | 5N - 1bar - 5.000 ciclos | • | • | • |
| Resistencia choque térmico | 20°C - 70°C - 1bar - 300 ciclos | • | • | • |
| Resistencia a la torsión | 15min | • | • | - |

PACKAGING Y ETIQUETADO DE NUESTROS PRODUCTOS

ETIQUETADO: El etiquetado de los productos incluye información descriptiva en múltiples idiomas, código de barras EAN-13 y mensajes destinados al usuario: marca del producto, logotipo, instrucciones de manejo, precauciones de uso, etc.

Distintivo Punto Verde, que asegura que los envases son recogidos selectivamente y son recuperados para su posterior tratamiento, reciclado y valoración.

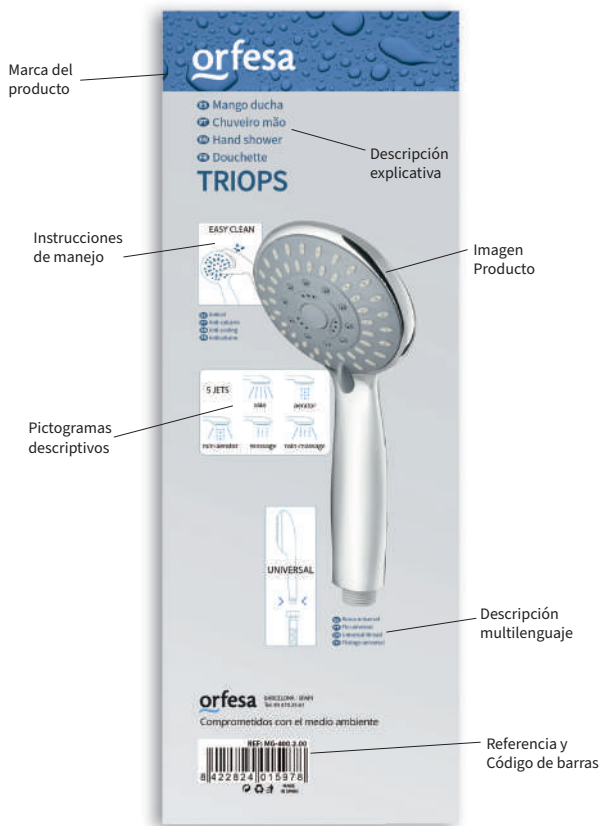

SIN ENVASAR "0.0": Artículos presentados con el a granel en envases convencionales de tipo almacén.

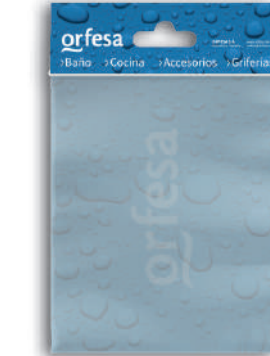

EN BOLSA CON SOLAPA "6.6":

Refuerzo con eurotaladro para colgar. Artículos presentados en bolsa para su implantación en lineales. **Provistos de EAN**, mensajes destinados al usuario: marca del producto, logotipo, instrucciones de manejo, precauciones de uso, etc.

EN CAJA "5.5": Especialmente diseñado para protegerlo de golpes durante las operaciones de manipulado y transporte. Permite exponer artículos ordenadamente. **Provistos de EAN**, mensajes destinados al usuario: marca del producto, logotipo, instrucciones de manejo, precauciones de uso, etc.



EN BLÍSTER "2.2": Especialmente diseñado para protegerlo de golpes durante las operaciones de manipulado y transporte.

Provistos de EAN, mensajes destinados al usuario: marca del producto, logotipo, instrucciones de manejo, precauciones de uso, etc.



LINEALES Y EXPOSITORES, PRESENCIA DEL PRODUCTO



Orfesa le ayuda a vender más, exponiendo la mercancía de manera eficiente y atractiva, dando más valor al producto. Ayudando a gestionar el espacio y adecuarlo a las necesidades de sus clientes.

Nuestros lineales, se adaptan a cada tienda en función de su tamaño, especialidad y tipo de público.

Nuestro equipo comercial está formado para asesorarte sobre lo más conveniente para cada una de tus tiendas, y realizamos propuestas personalizadas con planogramas reales para optimizar tu espacio.

Además, te ayudamos a montar tus lineales para que las mejoras en tu tienda sean sencillas y rápidas.

LINEAL 1 METRO: Es el tamaño mínimo que recomendamos para poder dar soluciones.

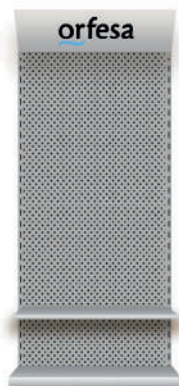

LINEAL 2 METROS: Es el tamaño óptimo para ofrecer todo tipo de soluciones, en formatos distintos según el tipo de público.



LINEAL 3 METROS: Es el tamaño ideal para tiendas de gran tamaño que quieren ofrecer a sus clientes todas las soluciones posibles.



EXPOSITOR DE SOBREMESA: Construidos en cartón y papel, se usan principalmente para exponer nuestras llaves de lujo.



EXPOSITOR MESA: Para disponer de la gama básica de ahorro de agua.



DISPLAY MESA: Utilizado para mostrar los productos unitarios de manera atractiva.





AHORRO DE AGUA

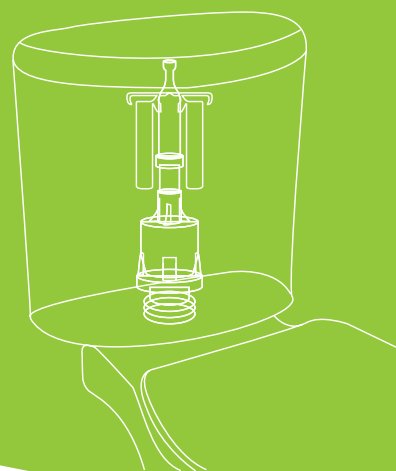
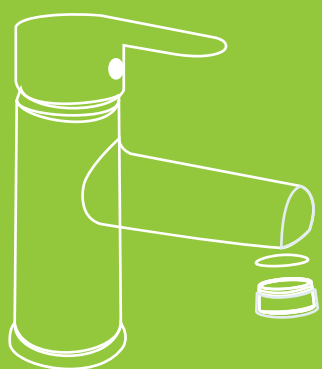

VENTAJA DE LOS SISTEMAS AHORRO ORFESA

1

Consumiendo menos agua fría y caliente, mediante el uso de productos Orfesa, se puede lograr **ahorro de litros, combustibles, reducción de emisiones de CO2 a la atmósfera y el consiguiente ahorro de dinero.**

❶ Cálculo en base a una familia de 3 personas.



Ahorro 24.000 litros
Ahorro 156 €



Ahorro 636 Kw/h
Ahorro 165 Kg de CO2

2

Fabricado con plásticos técnicamente preparados para **retrasar la adherencia** de la cal contenida en el agua. Diseñados con paredes muy finas dejando más espacio para la superficie de filtrado, permitiendo lograr una **eficacia mayor en el filtrado de residuos y calcio.**

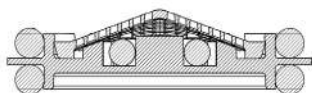

Retrasa la adherencia de residuos

3

Diseñado con una **geometría de volcán** innovadora que permite **prolongar su funcionamiento.**



Anticalcáreo
orfesa

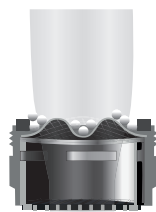

Geometría de volcán
=
Larga vida

4

Llave multiuso para **instalación y limpieza** del canal de aireación.



Fácil limpieza de residuos



FILTRO AHORRO 50%



Incluido en los siguiente productos

- Ahorro energético y consumo de agua.
- Filtro larga vida, Anti-calcáreo.
- Adecuado para cocina y baño.

| Referencia | Diámetro | Embalaje | P.V.P. |
|-------------|----------|---------------|--------|
| ES-050.2.00 | 21 mm. | Blíster 2 ud. | 2,54 € |

Disponibles más filtros desde 3 a 14 l/min.

Normas:

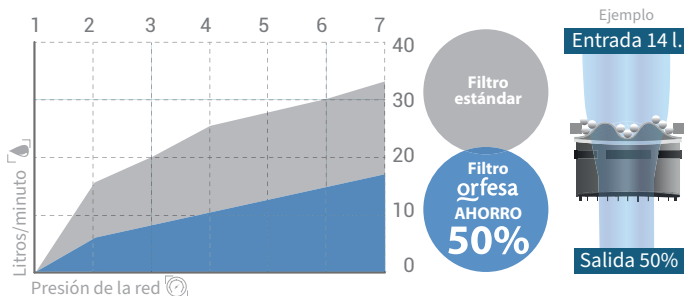

AIREADORES AHORRO 50%

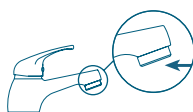

- Ahorro energético y consumo de agua.
- Filtro larga vida, Anti-calcáreo.
- Adecuado para cocina y baño.
- Juntas incluidas



NOVEDAD



NOVEDAD

| | Referencia | Rosca | Embalaje | Precio |
|---------|---------------|-------|----------|-----------------------------|
| Cromado | ES-100.0.00 | | Granel | 1,27 € |
| | ES-100.2.00 | M24 | Blíster | 2,05 € |
| | ES-100.4.00 | | Caja 10 | 1,41 € (precio x unidad) |
| | ES-110.0.00 | | Granel | 1,35 € |
| | ES-110.2.00 | H22 | Blíster | 2,13 € |
| | ES-110.4.00 | | Caja 10 | 1,49 € (precio x unidad) |
| Oro | ES-101.2.00 | M24 | Blíster | 3,36 € |
| | ES-111.2.00 | H22 | Blíster | 3,40 € |
| Negro | ES-100NG.2.00 | M24 | Blíster | 4,31 € |
| | ES-110NG.2.00 | H22 | | 4,72 € |
| Blanco | ES-100BL.2.00 | M24 | Blíster | 4,31 € |
| | ES-110BL.2.00 | H22 | | 4,72 € |

Normas:

ESTABILIZADOR CAUDAL



Incluido en los siguientes productos

- Caudal constante independientemente de la presión de la red y de la abertura del grifo.
- Ahorro energético y consumo de agua.
- Filtro larga vida, Anti-calcáreo.
- Adecuado para cocina y baño.

✂ Disponible más filtros desde 3 a 14 l/min.

🔗 Normas:

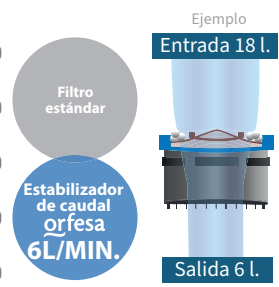
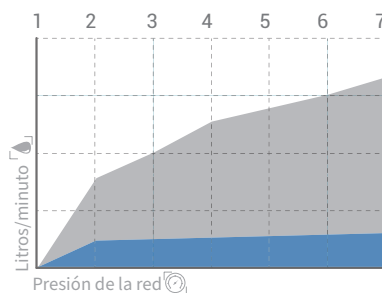

AIREADOR MULTIPOSICIÓN



- Ahorro energético y consumo de agua.
- Filtro larga vida, Anti-calcáreo.
- Adecuado para cocina y baño.



▶ Incluye ▶ Filtro AHORRO 50%

| | Referencia | Rosca | Embalaje | Precio |
|---------|-------------|-------|----------|--------|
| Cromado | ES-121.2.00 | M24 | Blíster | 6,27 € |
| | ES-122.2.00 | H22 | Blíster | 6,19 € |

AIREADORES ESTABILIZADORES

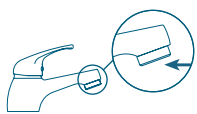

- Ahorro energético y consumo de agua.
- Filtro larga vida, Anti-calcáreo.
- Adecuado para cocina y baño.



| | Referencia | Caudal | Rosca | Embalaje | Precio |
|---------|-------------|----------|-------|----------|--------|
| Cromado | ES-105.0.00 | 6 l/min. | M24 | Granel | 2,54 € |
| | ES-105.2.00 | | | Blíster | 3,32 € |
| | ES-115.0.00 | | H22 | Granel | 3,03 € |
| | ES-115.2.00 | | | Blíster | 3,77 € |

✂ Disponible más estabilizadores desde 3 a 14 l/min.

🔗 Normas:

RÓTULA BIDÉ AHORRO 50%



- Ahorro energético y consumo de agua.
- Filtro larga vida, Anti-calcáreo.
- Adecuado para baño.

► Incluye ►

Filtro AHORRO 50%



| | Referencia | Rosca | Embalaje | Precio |
|---------|-------------|-------|----------|--------|
| Cromado | ES-161.2.00 | M24 | Blíster | 5,48 € |
| | ES-171.2.00 | H22 | Blíster | 5,33 € |

ESTABILIZADORES

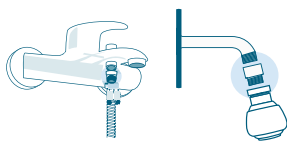

► Incluye ►

Estabilizador de caudal 9L/MIN



| | Referencia | Válvula Anti-retorno | Rosca | Embalaje | Precio |
|---------|-------------|----------------------|-------------|----------|--------|
| Cromado | ES-220.0.00 | | M1/2 - H1/2 | Granel | 5,95 € |
| | ES-220.2.00 | | | Blíster | 6,97 € |
| | ES-221.0.00 | NO | M1/2 - H1/2 | Granel | 3,20 € |
| | ES-221.2.00 | | | Blíster | 4,43 € |

Normas:

VÁLVULA ANTI-RETORNO Y ESTABILIZADOR DE CAUDAL

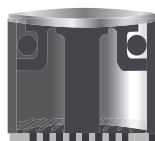

- Fabricado con membrana sensible a la presión, reduciendo hasta un 60% el flujo de agua.
- Ahorro energético y consumo de agua.
- Evita el reflujos de agua y golpes de ariete.
- Diámetro: 14mm.

Válvula Anti-retorno

La válvula antirretorno protege la grifería y el sistema de instalación del reflujos no deseado de agua sucia con impurezas en el sistema de tuberías.

Además evita que se produzcan flujos cruzados. Impiden que el agua caliente pueda ir a parar a la tubería de agua fría y viceversa.

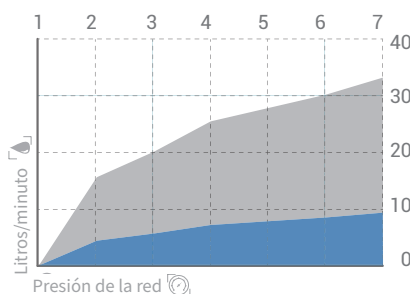

Filtro estándar

Estabilizador de caudal 9L/MIN.

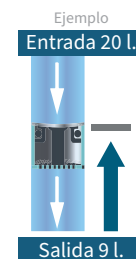



MANGO XANTI

- Ø 89 • Cromado
- Antical
- 3 posiciones

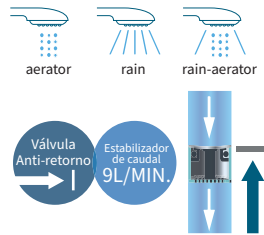

| Referencia | Embalaje | Precio |
|-------------|--------------|---------|
| MG-171.6.00 | Bolsa Solapa | 11,46 € |
| MG-171.5.00 | Caja | 12,30 € |



ROCIADOR BAÑO

- Con rótula
- Antical
- Rosca H1/2
- Ø 9,2 cm
- 5 posiciones

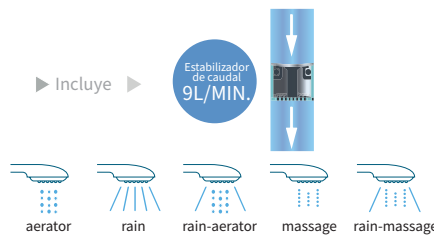

| Referencia | Embalaje | Precio |
|-------------|----------|---------|
| RC-075.5.00 | Bolsa | 19,76 € |



MANGO STUDIO COCINA

- Cromado
- Doble cámara aislante del calor
- 2 posiciones

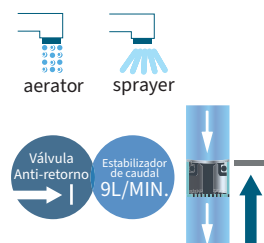

| Referencia | Embalaje | Precio |
|-------------|--------------|---------|
| MG-320.6.00 | Bolsa Solapa | 13,53 € |
| MG-320.5.00 | Caja | 14,15 € |

Normas: ACS

FLEXO ESTÁNDAR DOBLE



► Incluye ►

Estabilizador de caudal
9L/MIN.



· Tuerca latón



1/2"

· Tuerca cónica latón



1/2"

· Grapado doble



| Referencia | Longitud | Embalaje | Precio |
|--------------------|----------|----------|---------|
| inoxidable cromado | | | |
| FL-171.6.00 | | Solapa | 11,06 € |
| | 1.70 m. | | |
| FL-171.5.00 | | Caja | 11,85 € |

Normas: ACS

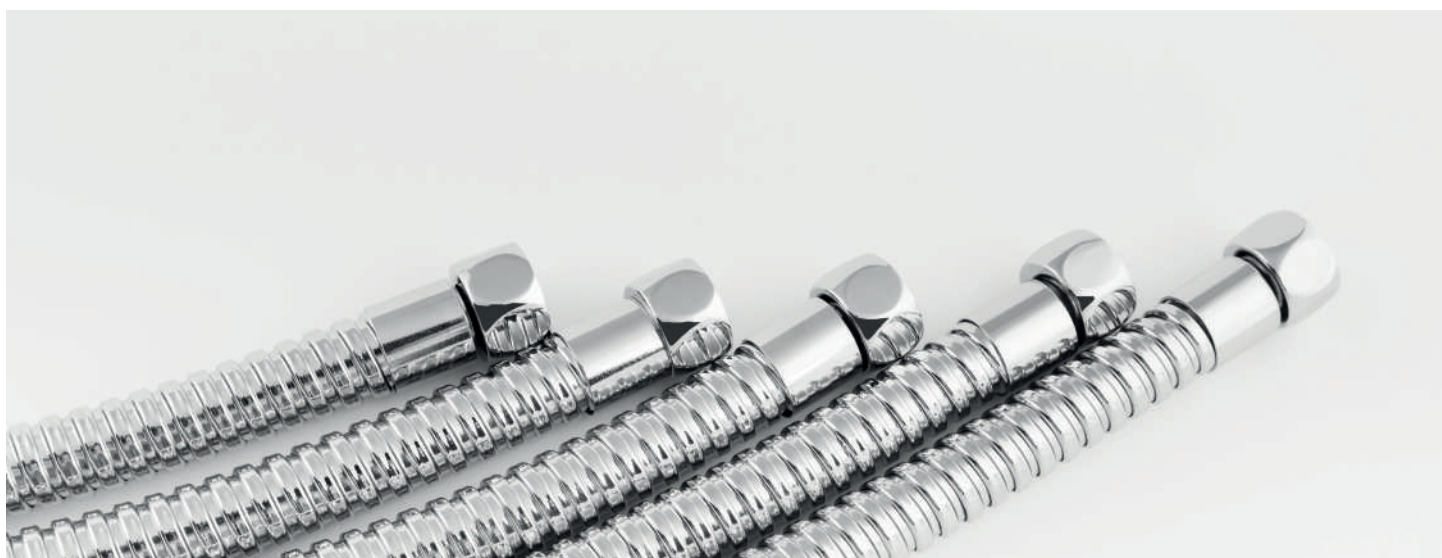

NOVEDAD AIREADOR MULTIPOSICIÓN ORIENTABLE



- Ahorro energético y consumo de agua.
- Filtro larga vida, Anti-calcáreo.
- Adecuado para cocina y baño.
- Orientable



► Incluye ► **Filtro AHORRO 50%** 

| | Referencia | Rosca | Embalaje | Precio |
|---------|-------------|-------|----------|--------|
| Cromado | ES-123.2.00 | M24 | Blíster | 7,32 € |
| | ES-124.2.00 | H22 | Blíster | 7,20 € |

ROCIADOR COCINA



- Cromado
- Adaptador H22-M24
- Con rótula.
- 2 posiciones





► Incluye ► **Estabilizador de caudal 9L/MIN.** 

| Referencia | Embalaje | Precio |
|-------------|----------|--------|
| RC-145.2.00 | Blíster | 8,82 € |

⊕ Disponible adaptador (RA-561) (RA-560) | Apartado racorería

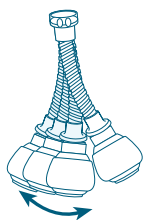
AIREADORES FLEXIBLES COCINA



► Incluye ► **Estabilizador de caudal 9L/MIN.** 

| | Referencia | Rosca | Embalaje | Precio |
|---------|-------------|---------------------------|----------|---------|
| Cromado | ES-193.2.00 | H22 + Adaptador M22 / M24 | Blíster | 10,05 € |
| | | | | |
| Cromado | ES-209.2.00 | H22 + Adaptador M22 / M24 | Blíster | 10,37 € |
| | | | | |

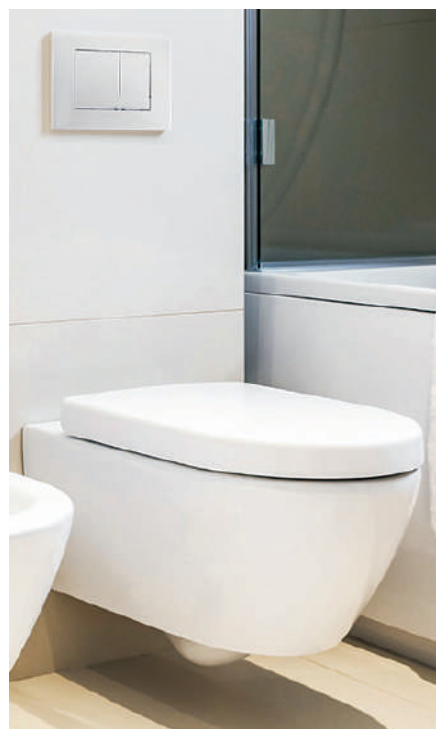

CISTERNA W.C. EMPOTRABLE

- Doble descarga: 3l - 6l Regulable
- Tanque oculto
- Altura regulable ↓
- Botón compatible con Geberit

| Referencia | Embalaje | Precio |
|-------------|----------|----------|
| AQ-112.5.00 | Caja | 340,38 € |

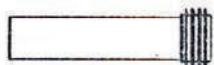
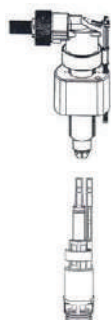

Componentes

| | | | |
|--------------------------------|-------------|-------|---------|
| Placa accionamiento negro mate | PC090P | Grael | 47,15 € |
| Placa accionamiento satinado | PC097W | Grael | 47,15 € |
| Grifo de llenado | TB-WR050012 | Grael | 43,46 € |
| Mecanismo de descarga | VD-WR050012 | Grael | 43,46 € |
| Tubo alimentación | TS-WR050012 | Grael | 36,68 € |

MECANISMOS DE DESCARGA CISTERNA W.C.

· Universales

| Referencia | Embalaje | Precio |
|-------------|----------|---------|
| AQ-107.5.00 | Caja | 24,47 € |

START/STOP

· Permite detener la descarga de forma voluntaria para no malgastar más agua de la necesaria.



● Incluye: junta, tornillos y llave



● Recambio juntas y tornillos (JG-AQ.7.00)

NOVEDAD

DOBLE PULSADOR

· Accionado por cable
· Válvula regulable

AQ-103.5.00

Caja

27,60 €

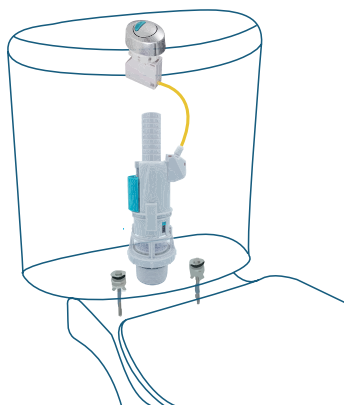

Doble Pulsador Half/Full

Tubo de desbordamiento ajustable

Ajuste del pulsador -> Full
Permite ajustar de 1 a 10 litros

Ajuste del pulsador -> Half
Permite ajustar de 1 a 5 litros

Bases intercambiables

BASES COMPATIBLES

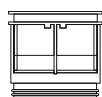

BASE GRIS



BASE BLANCA

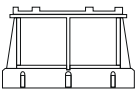

BASE BAYONETA



BASE ROSCADA

RECAMBIO PULSADOR

· Para descarga doble

| Referencia | Embalaje | P.V.P. |
|-------------|----------|--------|
| AQ-124.6.00 | Solapa | 6,36 € |



Recambio junta y tornillos (JG-AQ.7.00) Normas:

GRIFOS DE LLENADO W.C.

- Permiten regular la cantidad de agua.
- Rosca 3/8"
- Ajustable (8 - 12 cm altura)

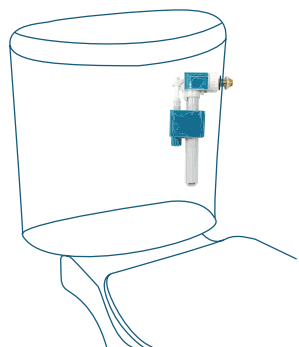

Normas: **CE**

| Referencia | Rosca | Embalaje | Precio |
|-------------|-------|----------|---------|
| AQ-101.5.00 | Latón | Caja | 12,86 € |

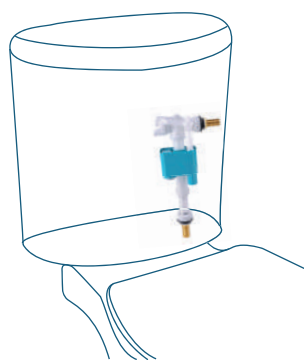

Normas: **CE**

| | | | |
|-------------|-------|------|---------|
| AQ-102.5.00 | Latón | Caja | 16,18 € |
|-------------|-------|------|---------|

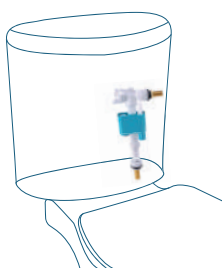
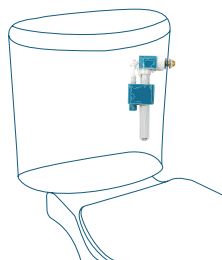

Normas: **CE**

| | | | |
|-------------|-------|------|---------|
| AQ-108.5.00 | Latón | Caja | 17,37 € |
|-------------|-------|------|---------|



BAÑO

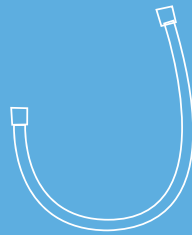
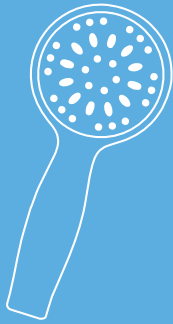
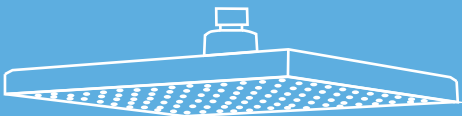
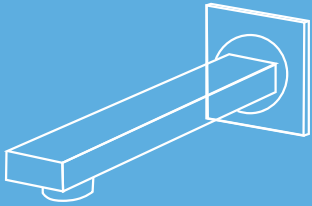



MANGO CHROME

- Ø 120
- Cromado
- Antical
- 3 posiciones



Normas:

| Referencia | Embalaje | Precio |
|---------------|--------------|---------|
| MG-800CR.6.00 | Bolsa solapa | 23,88 € |
| MG-800CR.5.00 | Caja | 24,57 € |



MANGO BLACK

- Ø 120
- Antical
- 3 posiciones



Normas:

| Referencia | Embalaje | Precio |
|---------------|--------------|---------|
| MG-800NG.6.00 | Bolsa solapa | 28,14 € |
| MG-800NG.5.00 | Caja | 28,99 € |



MANGO SIGNO

- Ø 100
- Cromado
- Antical
- 1 posición



| Referencia | Embalaje | Precio |
|-------------|--------------|--------|
| MG-680.6.00 | Bolsa solapa | 7,02 € |
| MG-680.5.00 | Caja | 8,86 € |



MANGO HYDRA

- Ø 100
- Negro mate
- Antical
- 1 posición



| Referencia | Embalaje | Precio |
|---------------|--------------|---------|
| MG-680NG.6.00 | Bolsa solapa | 16,59 € |
| MG-680NG.5.00 | Caja | 18,20 € |



MANGO RAL-3

- Ø 89
- Cromado
- Antical
- 1 posición



| Referencia | Embalaje | Precio |
|-------------|--------------|--------|
| MG-410.6.00 | Bolsa solapa | 8,80 € |
| MG-410.5.00 | Caja | 9,20 € |



MANGO RIALP

- Ø 89
- Cromado
- Antical
- 3 posiciones



| Referencia | Embalaje | Precio |
|-------------|--------------|---------|
| MG-170.6.00 | Bolsa solapa | 10,20 € |
| MG-170.5.00 | Caja | 10,60 € |



MANGO TRIOPS

- Ø 104
- Cromado
- Antical
- Hidromasaje
- 5 posiciones



| Referencia | Embalaje | Precio |
|-------------|----------|---------|
| MG-400.6.00 | Solapa | 13,64 € |
| MG-400.5.00 | Caja | 15,95 € |



MANGO ZENOS

- Ø 100
- Negro mate
- Antical
- 3 posiciones



| Referencia | Embalaje | Precio |
|---------------|--------------|---------|
| MG-693NG.6.00 | Bolsa solapa | 16,59 € |
| MG-693NG.5.00 | Caja | 18,20 € |



MANGO CENIT

- Ø 120
- Cromado
- Antical
- 5 posiciones



| Referencia | Embalaje | Precio |
|-------------|--------------|---------|
| MG-700.6.00 | Bolsa solapa | 11,09 € |
| MG-700.5.00 | Caja | 12,96 € |



MANGO RYDER

- Ø 91
- Cromado
- Antical
- 3 posiciones



| Referencia | Embalaje | Precio |
|-------------|--------------|--------|
| MG-690.6.00 | Bolsa solapa | 8,10 € |
| MG-690.5.00 | Caja | 9,75 € |



MANGO SIRA BLANCO

- Ø 94
- Blanco
- Antical
- 1 Posición



| Referencia | Embalaje | Precio |
|-------------|--------------|--------|
| MG-685.6.00 | Bolsa solapa | 4,98 € |
| MG-685.5.00 | Caja | 5,71 € |



MANGO CENIT BLANCO

- Ø 98
- Blanco
- Antical
- 5 posiciones



| Referencia | Embalaje | Precio |
|-------------|--------------|--------|
| MG-705.6.00 | Bolsa solapa | 6,52 € |
| MG-705.5.00 | Caja | 7,18 € |



MANGO VALI BLANCO

- Ø 100
- Blanco
- Antical
- 3 posiciones



| Referencia | Embalaje | Precio |
|-------------|--------------|--------|
| MG-695.6.00 | Bolsa solapa | 5,57 € |
| MG-695.5.00 | Caja | 6,35 € |



MANGO ONIX CUADRADO

- Cromado
- Cuadrado
- Minimalista
- 1 posición



| Referencia | Embalaje | Precio |
|-------------|--------------|--------|
| MG-740.6.00 | Bolsa solapa | 9,45 € |
| MG-740.5.00 | Caja | 9,90 € |



MANGO ONIX CUADRADO

- Negro
- Cuadrado
- Minimalista
- 1 posición



| Referencia | Embalaje | Precio |
|---------------|--------------|---------|
| MG-740NG.6.00 | Bolsa solapa | 13,98 € |
| MG-740NG.5.00 | Caja | 14,63 € |



MANGO AMBAR REDONDO

- Cromado
- Redondo
- Minimalista
- 1 posición



| Referencia | Embalaje | Precio |
|-------------|--------------|--------|
| MG-730.6.00 | Bolsa solapa | 8,89 € |
| MG-730.5.00 | Caja | 9,64 € |



MANGO AMBAR REDONDO

- Negro
- Redondo
- Minimalista
- 1 posición



| Referencia | Embalaje | Precio |
|---------------|--------------|---------|
| MG-730NG.6.00 | Bolsa solapa | 12,92 € |
| MG-730NG.5.00 | Caja | 13,31 € |



MANGO COOL

- Cromado
- Antical
- 1 posición



| Referencia | Embalaje | Precio |
|-------------|--------------|---------|
| MG-790.6.00 | Bolsa solapa | 15,55 € |
| MG-790.5.00 | Caja | 16,39 € |



MANGO CORIA BLANCO

- Ø 70
- Blanco
- Antical
- 1 posición



| Referencia | Embalaje | Precio |
|---------------|----------|--------|
| MG-092BL.6.00 | Solapa | 3,83 € |
| MG-092BL.7.00 | Bolsa | 2,57 € |



MANGO CORIA

- Ø 73
- Cromado
- Antical
- 1 posición



| Referencia | Embalaje | Precio |
|-------------|----------|--------|
| MG-092.6.00 | Solapa | 4,25 € |
| MG-092.7.00 | Bolsa | 3,70 € |



MANGO EDIT

- Ø 98
- Cromado
- Antical
- 1 posición



| Referencia | Embalaje | Precio |
|-------------|--------------|--------|
| MG-683.6.00 | Bolsa solapa | 6,05 € |
| MG-683.5.00 | Caja | 7,81 € |



MANGO UNNI

- Ø 105
- Cromado
- Antical
- 5 posiciones



| Referencia | Embalaje | Precio |
|-------------|--------------|--------|
| MG-703.6.00 | Bolsa solapa | 9,25 € |
| MG-703.5.00 | Caja | 9,75 € |



MANGO THINK

- Ø 94
- Cromado
- Antical
- 3 posiciones



| Referencia | Embalaje | Precio |
|-------------|--------------|--------|
| MG-693.6.00 | Bolsa solapa | 8,95 € |
| MG-693.5.00 | Caja | 9,86 € |



MANGO CLASSIC

- Cromo
- Antical
- Con codo
- 1 posición



| Referencia | Embalaje | Precio |
|-------------|--------------|---------|
| MG-080.6.00 | Bolsa solapa | 18,17 € |
| MG-080.5.00 | Caja | 18,57 € |



MANGO CLASSIC LATÓN VIEJO

- Latón viejo
- Antical
- Con codo
- 1 posición



| Referencia | Embalaje | Precio |
|---------------|--------------|---------|
| MG-080LT.6.00 | Bolsa solapa | 21,41 € |
| MG-080LT.5.00 | Caja | 21,80 € |

CODO PARA MANGO DE DUCHA

Cromado



| Referencia | Rosca | Embalaje | Precio |
|-------------|---------------|--------------|--------|
| PLÁSTICO | | | |
| MG-340.6.00 | H1/2" - M1/2" | Bolsa Solapa | 2,02 € |



FLEXO ESTÁNDAR SIMPLE



- Tuerca ABS  1/2"
- Tuerca cónica ABS  1/2"
- Grapado simple 



| | Referencia | Longitud | Embalaje | Precio |
|------------|--------------|----------|--------------|--------|
| Inoxidable | FL-1801.6.00 | 1.50 m. | Bolsa solapa | 5,14 € |
| | FL-1801.5.00 | | Caja | 5,53 € |
| | FL-1901.6.00 | 1.70 m. | Bolsa solapa | 5,45 € |
| | FL-1901.5.00 | | Caja | 5,85 € |
| | FL-2001.6.00 | 2.00 m. | Bolsa solapa | 5,73 € |
| | FL-2001.5.00 | | Caja | 6,12 € |

Normas: 

FLEXO ESTÁNDAR SIMPLE REFORZADO

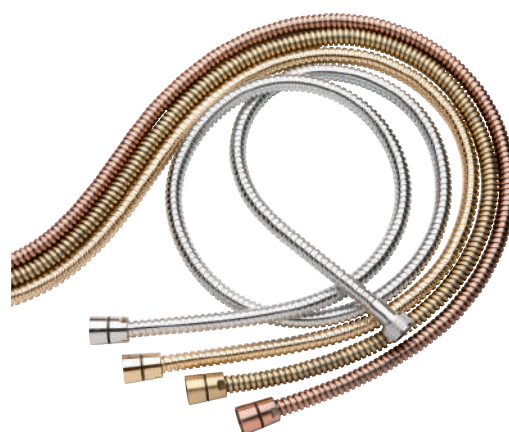

- Tuerca latón  1/2"
- Tuerca cónica latón  1/2"
- Grapado simple 
- Chapa reforzada 







| | Referencia | Longitud | Embalaje | Precio |
|--------------------|--------------|----------|--------------|---------|
| Inoxidable cromado | FL-100.6.00 | 1,50 m. | Bolsa solapa | 7,42 € |
| | FL-100.5.00 | | Caja | 8,38 € |
| | FL-194.6.00 | 1,70 m. | Bolsa solapa | 7,63 € |
| | FL-194.5.00 | | Caja | 8,64 € |
| | FL-110.6.00 | 2,00 m. | Bolsa solapa | 8,71 € |
| | FL-110.5.00 | | Caja | 9,54 € |
| Oro | FL-074.6.00 | | Bolsa solapa | 48,48 € |
| | FL-074.5.00 | | Caja | 49,36 € |
| Bronce | FL-194L.6.00 | 1,70 m. | Bolsa solapa | 22,04 € |
| | FL-194L.5.00 | | Caja | 22,44 € |
| Cobre | FL-194C.6.00 | | Bolsa solapa | 22,04 € |
| | FL-194C.5.00 | | Caja | 22,44 € |

Normas: 

FLEXO ESTÁNDAR DOBLE







- Tuerca latón  1/2"
- Tuerca cónica latón  1/2"
- Grapado doble 
-  80kg

| | Referencia | Tuerca giratoria Antitorsión | Longitud | Embalaje | Precio |
|--------------------|-------------|---|----------|--------------|---------|
| Inoxidable cromado | FL-174.6.00 | | 1.50 m. | Bolsa solapa | 7,43 € |
| | FL-174.5.00 | | | Caja | 7,82 € |
| | FL-400.6.00 |  | 1.70 m. | Bolsa solapa | 8,30 € |
| | FL-400.5.00 | | | Caja | 8,69 € |
| | FL-170.6.00 | | | Bolsa solapa | 7,90 € |
| | FL-170.5.00 | | | Caja | 8,30 € |
| Oro | FL-073.6.00 | | 1.70 m. | Solapa | 47,52 € |
| | FL-073.5.00 | | | Caja | 46,89 € |

Normas: 

FLEXO EXTENSIBLE DOBLE







- Tuerca latón  1/2"
- Tuerca cónica latón  1/2"
- Grapado doble 
-  80kg

| | Referencia | Longitud | Embalaje | Precio |
|--------------------|-------------|--|--------------|--------|
| Inoxidable | FL-360.6.00 |  Extensible 1.70 - 2.25 m | Bolsa solapa | 7,08 € |
| | FL-360.5.00 | | Caja | 7,74 € |
| Inoxidable cromado | FL-370.6.00 | | Bolsa solapa | 8,81 € |
| | FL-370.5.00 | | Caja | 9,55 € |

Normas: 

FLEXO BAJA PRESIÓN







- Tuerca latón  1/2"
 - Tuerca cónica latón  1/2"
 - Grapado simple 
 - Chapa reforzada 
 - 
- Gran caudal.
 · Para calentador sin presión o aguas de despósito.

| | Referencia | Longitud | Embalaje | Precio |
|--------------------|--------------------|----------|--------------|----------------|
| Inoxidable cromado | FL-140.6.00 | 1.70 m. | Bolsa solapa | 10,15 € |
| | FL-140.5.00 | | Caja | 10,55 € |

Normas: 

FLEXO EXTRAÍBLE BAÑERA







- Boquilla loca  15/100"
- Tuerca cónica latón  1/2"
- Grapado simple 
- 

| | Referencia | Longitud | Embalaje | Precio |
|------------|---------------------|----------|--------------|---------------|
| Inoxidable | FL-126I.6.00 | 2.00 m | Bolsa solapa | 7,11 € |
| | FL-126I.5.00 | | Caja | 7,51 € |

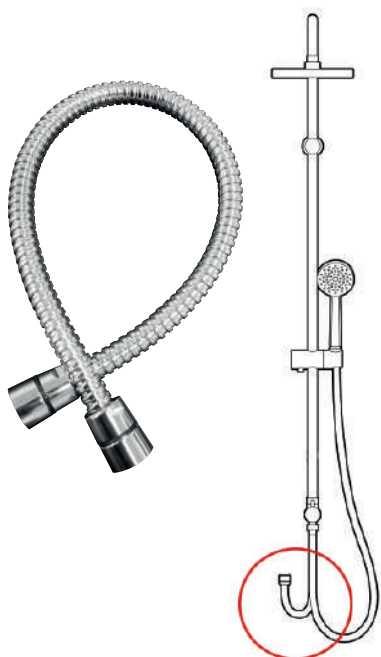
Normas: 

FLEXO ESPECIAL COLUMNA



- Tuerca cónica latón  1/2"
- Tuerca cónica latón  1/2"
- Grapado doble 
- 

| | Referencia | Longitud | Embalaje | Precio |
|--------------------|--------------------|----------|--------------|---------------|
| Inoxidable cromado | FL-018.6.00 | 0.50 m | Bolsa solapa | 6,36 € |
| | FL-018.5.00 | | Caja | 6,75 € |
| | FL-172.6.00 | 1.00 m | Bolsa solapa | 6,95 € |
| | FL-172.5.00 | | Caja | 7,35 € |

Normas: 

FLEXO SILVER



· Tuerca cónica latón Anti-enrollable 1/2"  · Tuerca cónica latón 1/2" 

| | Referencia | Longitud | Embalaje | Precio |
|--------|-------------|--------------|--------------|---------|
| Plata | FL-328.6.00 | 1.70 m | Bolsa solapa | 11,02 € |
| | FL-328.5.00 | | Caja | 11,85 € |
| Negro | FL-346.6.00 | | Bolsa solapa | 15,80 € |
| | FL-346.5.00 | | Caja | 16,20 € |
| Blanco | FL-345.6.00 | Bolsa solapa | 14,49 € | |
| | FL-345.5.00 | Caja | 14,98 € | |

ADAPTADOR GRIFO BAÑO/COCINA PARA MANGUERA 3/4"



Salida 3/4 para conectar manguera

| | Referencia | Embalaje | Precio |
|--|-------------|----------|--------|
| Adaptador M24 / M22 + Aireador Inoxidable cromado Entrada H22 - Salida 3/4" | ES-305.2.00 | Blíster | 5,33 € |

+ Disponible adaptador (RA-560)
Apartado racorería

AIREADOR

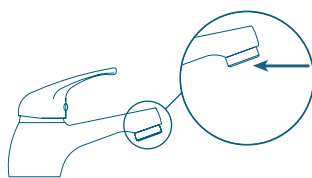

- Filtro larga vida
- Anti-calcáreo



| | Referencia | Rosca | Embalaje | Precio |
|---------------|-------------|-------|----------|--------------------------|
| Latón cromado | ES-076.0.00 | H16 | Granel | 2,96 € |
| | ES-076.2.00 | | Blíster | 3,75 € |
| | ES-075.0.00 | M18 | Granel | 3,04 € |
| | ES-075.2.00 | | Blíster | 3,79 € |
| | ES-070.0.00 | H18 | Granel | 3,36 € |
| | ES-070.2.00 | | Blíster | 4,19 € |
| | ES-030.0.00 | M20 | Granel | 3,52 € |
| | ES-030.2.00 | | Blíster | 4,35€ |
| | ES-060.0.00 | H22 | Granel | 1,29 € |
| | ES-060.4.00 | | Caja 10 | 1,46 € precio por ud. |
| | ES-060.2.00 | | Blíster | 2,04 € |
| | ES-010.0.00 | M24 | Granel | 1,22 € |
| | ES-010.4.00 | | Caja 10 | 1,38 € precio por ud. |
| | ES-010.2.00 | | Blíster | 1,97 € |
| | ES-020.0.00 | M28 | Granel | 1,94 € |
| | ES-020.2.00 | | Blíster | 2,92 € |
| Oro | ES-080.2.00 | H22 | Blíster | 4,74 € |
| | ES-028.2.00 | M28 | Blíster | 5,33 € |

Normas:

AIREADOR PARA GRIFOS SIN ROSCA



- Aireador para grifos sin rosca.

| | Referencia | Rosca | Embalaje | Precio |
|---------------|-------------|-----------|----------|--------|
| Latón cromado | ES-180.2.00 | Sin rosca | Blíster | 7,72 € |

RÓTULA BIDÉ CON AIREADOR

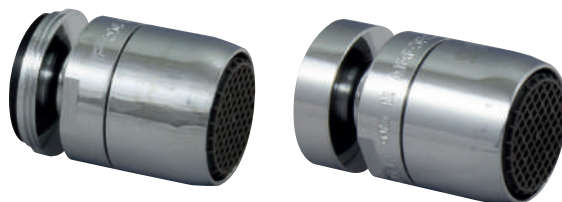

| | Referencia | Rosca | Embalaje | Precio |
|---------------|-------------|-------|----------|--------|
| Latón cromado | ES-160.2.00 | M24 | Blíster | 5,69 € |
| | ES-170.2.00 | H22 | Blíster | 5,73 € |

Normas: ACS kiwa K.T.W NSF NF

LLAVE MONTAJE Y LIMPIEZA

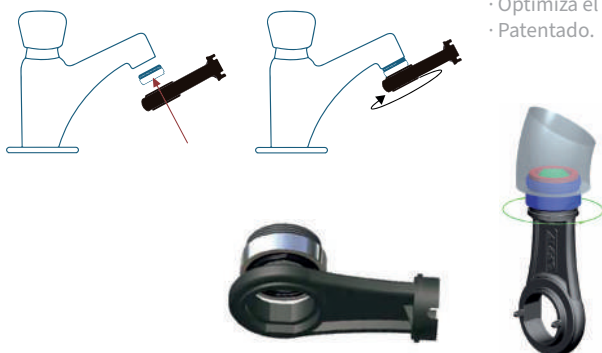

- Evolucionado sistema para instalación y limpieza.
- Optimiza el filtro para durar más tiempo sin necesidad de limpieza.
- Patentado.

| Referencia | Anti-vandálico | Rosca | Embalaje | Precio |
|---------------|----------------|-------|--------------|--------|
| ES-001.0.9999 | | M24 | Granel | 1,60 € |
| ES-001.2.00 | | | Blíster | 2,72 € |
| ES-002.0.00 | • | | Granel | 1,60 € |
| ES-002.6.00 | | | Bolsa solapa | 2,62 € |

Fabricación: AMFAG

LLAVE MONTAJE MULTI-ROSCA



- Evolucionado sistema para instalación y limpieza.
- Patentado.

| Referencia | Rosca | Embalaje | Precio |
|-------------|-----------------|--------------|--------|
| ES-003.0.00 | | Granel | 4,51 € |
| ES-003.2.00 | H22 - M24 - M28 | Blíster | 6,40 € |
| ES-003.6.00 | | Bolsa solapa | 5,13 € |

Fabricación: AMFAG

ROCIADOR CUADRADO ABS

- ABS
- Cromado
- Con rótula
- Rosca H1/2
- Normas:

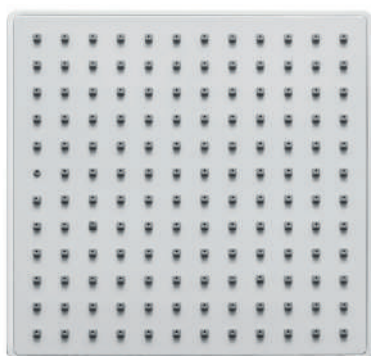

| Referencia | Medida | Color | Embalaje | Precio |
|---------------|-------------|---------|----------|---------|
| RC-210.5.00 | 20 x 20 cm. | Cromado | Caja | 28,17 € |
| RC-210NG.5.00 | | Negro | Caja | 30,13 € |



ROCIADOR REDONDO ABS

- ABS
- Con rótula
- Rosca H1/2
- Normas:



| Referencia | Medida | Color | Embalaje | Precio |
|---------------|----------|---------|----------|---------|
| RC-180.5.00 | Ø 20 cm. | Cromado | Caja | 26,86 € |
| RC-180NG.5.00 | | Negro | Caja | 29,48 € |



ROCIADOR CUADRADO METÁLICO

- Acero Inoxidable
- Cromado
- Con rótula
- Rosca H1/2
- Grosor 2,1 cm



| Referencia | Medida | Color | Embalaje | Precio |
|---------------|-------------|---------|----------|----------|
| RC-229.5.00 | 20 x 20 cm. | Cromado | Caja | 57,99 € |
| RC-229NG.5.00 | | Negro | | 77,66 € |
| RC-230.5.00 | 25 x 25 cm. | Cromado | Caja | 85,28 € |
| RC-230NG.5.00 | | Negro | | 106,61 € |
| RC-235.5.00 | 30 x 30 cm. | Cromado | | 108,07 € |

✂ Disponible en otras medidas

Normas:  

ROCIADOR REDONDO METÁLICO



- Acero Inoxidable
- Cromado
- Con rótula
- Rosca H1/2
- Grosor 2,1 cm



NOVEDAD



| Referencia | Medida | Color | Embalaje | Precio |
|---------------|----------|---------|----------|----------|
| RC-219.5.00 | Ø 20 cm. | Cromado | Caja | 43,45 € |
| RC-219NG.5.00 | | Negro | | 101,51 € |
| RC-220.5.00 | Ø 25 cm. | Cromado | Caja | 78,53 € |
| RC-220NG.5.00 | | Negro | | 106,45 € |
| RC-225.5.00 | Ø 30 cm. | Cromado | Caja | 109,02 € |
| RC-225NG.5.00 | | Negro | | 135,01 € |

Normas:  

ROCIADOR TRÍOPS BÁSICO

- Con rótula
- Antical
- Rosca H1/2
- Ø 10,5 cm
- 1 posición

| Referencia | Embalaje | Precio |
|-------------|----------|---------|
| RC-071.5.00 | Caja | 20,46 € |



ROCIADOR TRÍOPS RAIN/MASSAGE

- Con rótula
- Antical
- Rosca H1/2
- Ø 11 cm
- 5 posiciones

| Referencia | Embalaje | Precio |
|-------------|----------|---------|
| RC-070.5.00 | Caja | 13,04 € |

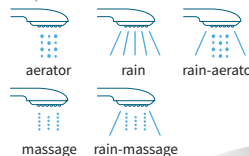

ROCIADOR PLÁSTICO

- Rosca H1/2
- Ø 5,3 cm
- 1 posición



| Referencia | Embalaje | Precio |
|-------------|--------------|--------|
| RC-170.7.00 | Bolsa | 1,48 € |
| RC-170.6.00 | Bolsa Solapa | 2,36 € |

ROCIADOR CONO

- Con rótula
- Rosca H1/2
- Ø 6,2 cm
- 1 posición



| Referencia | Embalaje | Precio |
|-------------|--------------|--------|
| RC-080.6.00 | Bolsa Solapa | 7,77 € |

BRAZOS DE DUCHA



Brazo pared con florón + Rotula H1/2"

FLORÓN



- Inoxidable cromado

| Referencia | Longitud | Acabado | Embalaje | Precio |
|---------------|----------|------------|--------------|---------|
| BR-060.6.00 | 16 cm | Cromado | Bolsa Solapa | 24,29 € |
| BR-040NG.5.00 | 35 cm | Negro mate | Caja | 14,10 € |
| BR-040.6.00 | 35 cm | Cromado | Bolsa Solapa | 11,75 € |

| Referencia | Medida | Embalaje | Precio | |
|--------------------|-------------|----------------|--------|--------|
| Corredero LISO | BR-100.0.00 | 1/2" x 5,5 cm. | Granel | 0,16 € |
| Corredero CON PUAS | BR-120.0.00 | 1/2" x 5,5 cm. | Granel | 0,25 € |

SOPORTE CÓNICO BLANCO



- Plástico
- Blanco

| Referencia | Embalaje | Precio |
|-------------|----------|--------|
| AB-150.6.00 | Solapa | 3,66 € |

SOPORTE CÓNICO CROMADO



- Plástico
- Cromado

| Referencia | Embalaje | Precio |
|-------------|----------|--------|
| AB-160.6.00 | Solapa | 3,95 € |

SOPORTE CÓNICO PRACTIC



- Plástico
- Cromado

| Referencia | Embalaje | Precio |
|-------------|----------|--------|
| AB-120.6.00 | Solapa | 5,14 € |

SOPORTE CÓNICO PRACTIC NEGRO



- Plástico
- Negro

| Referencia | Embalaje | Precio |
|---------------|----------|--------|
| AB-120NG.6.00 | Solapa | 8,94 € |

SOPORTE CÓNICO



- Plástico
- Cromado

| Referencia | Embalaje | Precio |
|-------------|----------|--------|
| AB-167.6.00 | Bolsa | 3,08 € |

SOPORTE CÓNICO VISIÓN



- Plástico
- Cromado

| Referencia | Embalaje | Precio |
|-------------|----------|--------|
| AB-110.6.00 | Bolsa | 6,99 € |

SOPORTE CÓNICO

- Cromado
- Multiposición



| | Referencia | Material | Embalaje | Precio |
|---------|-------------|----------|--------------|---------|
| CROMADO | AB-090.6.00 | Metálico | Bolsa solapa | 14,79 € |



| | | | | |
|--------|--------------|--------|--------------|---------|
| BRONCE | AB-090L.6.00 | Bronce | Bolsa solapa | 16,20 € |
|--------|--------------|--------|--------------|---------|

SOPORTE RÓTULA HORQUILLA PARA CODO

- Cromado
- Multiposición



| | Referencia | Material | Embalaje | Precio |
|--------|-------------|----------|--------------|--------|
| SIMPLE | AB-010.6.00 | Metálico | Bolsa solapa | 9,01 € |
| | AB-020.6.00 | Plástico | Bolsa solapa | 6,36 € |



| | | | | |
|-----------------------|-------------|----------|--------------|---------|
| CON TOMA DE AGUA 1/2" | AB-060.6.00 | Metálico | Bolsa solapa | 18,37 € |
|-----------------------|-------------|----------|--------------|---------|

⊕ Disponible accesorio CODO PARA MANGO DE DUCHA en el apartado accesorios de baño (MG-340) (MG-350)

BARRA UNIVERSAL BOSSE



| Referencia | Embalaje | Precio |
|-------------|----------|---------|
| AB-206.5.00 | Caja | 24,50 € |



UNIVERSAL

- Soportes y anclajes deslizantes
- Barra metálica

RECAMBIO SOPORTE

Universal D. 18 a 25 Cromado



| Referencia | Embalaje | Precio |
|-------------|--------------|--------|
| AB-195.6.00 | Bolsa solapa | 4,72 € |

BARRA SOAP



| Referencia | Embalaje | Precio |
|-------------|----------|---------|
| AB-200.5.00 | Caja | 18,00 € |

BARRA STYLE



| Referencia | Embalaje | Precio |
|-------------|----------|---------|
| AB-203.5.00 | Caja | 57,14 € |



UNIVERSAL

- Soportes y anclajes deslizantes
- Barra metálica

BARRA UNIVERSAL BOSSE NEGRA



| Referencia | Embalaje | Precio |
|---------------|----------|---------|
| AB-206NG.5.00 | Caja | 27,06 € |

ASIDEROS, BARRAS DE SUJECIÓN

1mm grosor
AISI 304



· Acero inoxidable
· Ø 25



| | Referencia | Medida | Embalaje | Precio |
|----------------|------------------|--------|----------|---------|
| SIMPLE | ASID-010.5.00 | 30 cm. | Caja | 14,59 € |
| ANTIDESLIZANTE | ASID-010ANT.5.00 | 30 cm. | Caja | 18,94 € |
| BLANCO | ASID-010BL.5.00 | 30 cm. | Caja | 13,21 € |
| NEGRO | ASID-010NG.5.00 | 30 cm. | Caja | 15,12 € |
| LARGO | ASID-020.5.00 | 50 cm. | Caja | 21,77 € |

BARRAS CORTINAS BAÑO

RECTA

| Referencia | Medida | Embalaje | Precio |
|--------------|---------------|----------|--------|
| BRC-010.2.00 | 70 x 120 cm. | Blíster | 6,69 € |
| BRC-020.2.00 | 110 x 200 cm. | Blíster | 8,40 € |
| BRC-030.2.00 | 140 x 260 cm. | Blíster | 9,81 € |

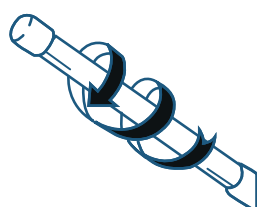

CURVA

| Referencia | Medida | Embalaje | Precio |
|---------------|-----------------|----------|---------|
| BRC-010C.2.00 | 80 x 80 cm. | Blíster | 8,20 € |
| BRC-020C.2.00 | 80 x 90-180 cm. | Blíster | 10,95 € |

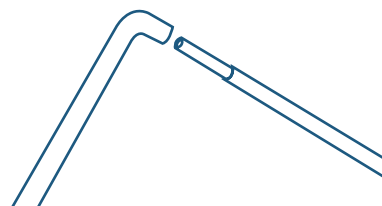



CONJUNTO RIALP

- Barra deslizante metálica con jabonera · AB-200
- Flexo extensible inox. · FL-360
- Mango RIALP · MG-170
- 3 posiciones



| Referencia | Embalaje | Precio |
|-------------|----------|---------|
| AB-230.5.00 | Caja | 45,10 € |



FL-360



MG-170



CONJUNTO TRIOPS

- Barra deslizante metálica con jabonera · AB-200
- Flexo extensible inox. · FL-360
- Mango TRIOPS · MG-400
- 5 posiciones



| Referencia | Embalaje | Precio |
|-------------|----------|---------|
| AB-240.5.00 | Caja | 47,76 € |



FL-360



MG-400



CONJUNTO RYDER

- Barra deslizante metálica con jabonera · AB-200
- Flexo estándar simple inox. · FL-190I
- Mango RYDER · MG-690
- 3 posiciones



| Referencia | Embalaje | Precio |
|-------------|----------|---------|
| AB-245.5.00 | Caja | 43,05 € |



FL-190I



MG-690



CONJUNTO BOSSE

- Barra deslizante metálica · AB-206
- Flexo extensible inox. cromado · FL-360
- Mango CENIT · MG-700
- 5 posiciones



| Referencia | Embalaje | Precio |
|-------------|----------|---------|
| AB-252.5.00 | Caja | 55,35 € |



FL-360



MG-700

KIT RIALP

- Soporte · AB-160
- Flexo extensible inox. 1,70-225m. · FL-360
- Mango RIALP cromado · MG-170
- 3 posiciones



AB-160



FL-360



MG-170

| Referencia | Embalaje | Precio |
|--------------|--------------|---------|
| KIT-003.6.00 | Bolsa Solapa | 21,39 € |

KIT RYDER

- Soporte · AB-160
- Flexo extensible inox. 1,70-225m. · FL-360
- Mango RYDER cromado · MG-690
- 3 posiciones



AB-160



FL-360



MG-690

| Referencia | Embalaje | Precio |
|--------------|--------------|---------|
| KIT-011.6.00 | Bolsa Solapa | 19,78 € |

KIT SIGNO

- Soporte · AB-160
- Flexo estándar simple inox. 1,70m. · FL-190I
- Mango SIGNO cromado · MG-680
- 1 posición



AB-160



FL-190I



MG-680

| Referencia | Embalaje | Precio |
|--------------|--------------|---------|
| KIT-015.6.00 | Bolsa Solapa | 16,56 € |

KIT CORIA

- Soporte · AB-160
- Flexo extensible inox. 1,70-225m. · FL-360
- Mango cromado · MG-092
- 1 posición



| Referencia | Embalaje | Precio |
|---------------------|--------------|----------------|
| KIT-016.6.00 | Bolsa solapa | 11,78 € |



AB-160



FL-360



MG-092

KIT CORIA BLANCO

- Soporte · AB-150
- Flexo extensible inox. 1,70-225m. · FL-360
- Mango cromado · MG-092
- 1 posición



| Referencia | Embalaje | Precio |
|-----------------------|--------------|----------------|
| KIT-016BL.6.00 | Bolsa solapa | 12,10 € |



AB-150



FL-360



MG-690

CONJUNTO HIGIÉNICO LUJO



- Para instalación junto al W.C
- Uso sustitutivo del bidé

| Referencia | Embalaje | Precio |
|--------------------|----------|----------------|
| AB-231.5.00 | Caja | 56,04 € |

Componentes

| | | |
|--|-------------|---------|
| Soporte cromado | AB-166.7.00 | 1,18 € |
| Flexo inoxidable cromado 1,20 m | FL-576.7.00 | 18,63 € |
| Mango con salida de agua automática 2 Posiciones | MG-480.7.00 | 29,11 € |
| Grifo de latón cromado 2 Salidas: Alimentación cisterna y toma de agua | GF-225.5.00 | 17,16 € |

CONJUNTO HIGIÉNICO ECONÓMICO



- Para instalación junto al W.C
- Uso como sustituto de bidé

| Referencia | Embalaje | Precio |
|--------------------|----------|----------------|
| AB-250.5.00 | Caja | 34,73 € |

Componentes

| | | |
|--|-------------|---------|
| Soporte cromado | AB-166.7.00 | 1,18 € |
| Flexo higiénico blanco 1,20 m | FL-258.7.00 | 12,68 € |
| Mango blanco con abre/cierre caudal | MG-257.7.00 | 3,71 € |
| Grifo de latón cromado 2 Salidas: Alimentación cisterna y toma de agua | GF-225.5.00 | 17,16 € |

CONJUNTO HIGIÉNICO CON MONOMANDO



- Para instalación junto al W.C
- Uso como sustituto de bidé

| Referencia | Embalaje | Precio |
|--------------------|----------|-----------------|
| AB-270.5.00 | Caja | 122,27 € |

Componentes

| | | |
|--|-------------|---------|
| Soporte cónico con toma de agua | AB-070.7.00 | 9,47 € |
| Flexo inoxidable cromado 1,20 m | FL-576.7.00 | 6,05 € |
| Mango con salida de agua automática 2 Posiciones | MG-480.7.00 | 29,11 € |
| Monomando de empotrar mezclador de agua fría y caliente | GF-240.5.00 | 55,06 € |

CONJUNTO HIGIÉNICO ECONÓMICO

- Para instalación junto al W.C.
- Uso como sustituto de bidé



| Referencia | Embalaje | Precio |
|-------------|----------|--------|
| AB-249.5.00 | Caja | 7,05 € |



· Soporte de pared



· Flexo cromado



· Mango cromado con abre/cierre caudal

NOVEDAD

CONJUNTO HIGIÉNICO ECONÓMICO

- Para instalación junto al W.C.
- Uso como sustituto de bidé



| Referencia | Embalaje | Precio |
|-------------|----------|---------|
| AB-259.5.00 | Caja | 28,09 € |



· Soporte de pared



· Flexo cromado



· Mango cromado con abre/cierre caudal



· Grifo de dos salidas



MANGO DUCHA HIGIENICO OVAL

- Para instalación junto al W.C.
- Con abre/cierre de caudal.

| Referencia | Embalaje | Precio |
|-------------|--------------|--------|
| MG-259.6.00 | Bolsa Solapa | 8,20 € |

LEYENDA:



EXTRAIBLE
Fácil limpieza.



CIERRE PROGRESIVO
Caída amortiguada de tapa y aro.



EXCÉNTRICA
Fácil instalación.

SÍBEL | TAPA WC OVALADA

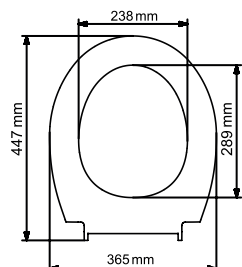

BISAGRA UNIVERSAL
110 min. - 180 max.

| Referencia | Embalaje | Precio |
|-------------|----------|---------|
| AB-320.5.00 | Caja | 31,06 € |



MIRAY | TAPA WC OVALADA

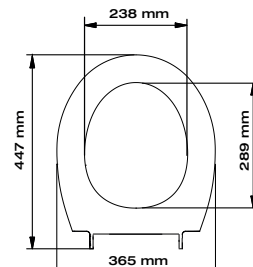

BISAGRA UNIVERSAL
110 min. - 180 max.

| Referencia | Embalaje | Precio |
|-------------|----------|---------|
| AB-325.5.00 | Caja | 35,75 € |



AYLIN | TAPA WC OVALADA

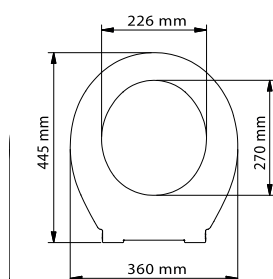

BISAGRA UNIVERSAL
110 min. - 180 max.

| Referencia | Embalaje | Precio |
|-------------|----------|---------|
| AB-335.5.00 | Caja | 38,40 € |



ZEHRA | TAPA WC RECTANGULAR

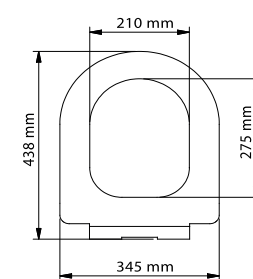

BISAGRA UNIVERSAL
110 min. - 180 max.

| Referencia | Embalaje | Precio |
|-------------|----------|---------|
| AB-345.5.00 | Caja | 40,32 € |



DERYA | TAPA WC OVALADA

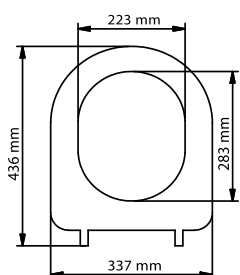

BISAGRA UNIVERSAL
110 min. - 180 max.

| Referencia | Embalaje | Precio |
|-------------|----------|---------|
| AB-355.5.00 | Caja | 33,21 € |



ASENA | TAPA WC RECTANGULAR OVALADA

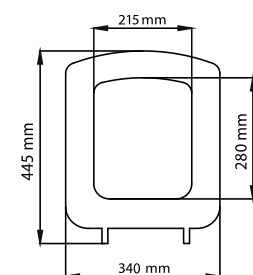

BISAGRA UNIVERSAL
110 min. - 180 max.

| Referencia | Embalaje | Precio |
|-------------|----------|---------|
| AB-365.5.00 | Caja | 34,85 € |



TABLA DE COMPATIBILIDADES

| Modelos Compatibles | | AB-320.5.00 | AB-325.5.00 | AB-335.5.00 | AB-345.5.00 | AB-355.5.00 | AB-365.5.00 |
|---------------------|----------------|-------------|-------------|-------------|-------------|-------------|-------------|
| Roca | Victoria | • | • | • | | | |
| | Laura | • | • | | | | |
| | Meridian | | | | • | • | • |
| Gala | Elia | | | • | | | |
| | Chile | | | • | | | |
| | Espacio | | | • | | | |
| | Nova Espacio | | | • | | | |
| | Mira | | | • | | | |
| | Neo | | | • | | | |
| | CIL 53 | | | • | | | |
| | Classica | | | • | | | |
| | Diana | | | • | | | |
| | Floria | | | | • | • | |
| | Gala 2000 | | | | • | • | |
| | Marina | | | | • | • | |
| | Metropol Susp. | | | | • | • | |
| Villeroy & Boch | Omnia Classic | • | | | | | |
| | Omnia Pro | • | | | | | |

EJE PORTARROLLOS

- Plástico
- Blanco



| Referencia | Embalaje | Precio |
|--------------|----------|--------|
| EJE-010.6.00 | Solapa | 1,48 € |

JUEGO EXCÉNTRICAS COMPLETA

- Plástico blanco
- Un juego de excéntricas
- Compatible con AB-335 | AB-345



| Referencia | Embalaje | Precio |
|-------------|----------|--------|
| AQ-122.7.00 | Bolsa | 0,17€ |

- Embellecedor metálico cepillado
- Un juego de excéntricas
- Compatible con AB-320 | AB-355



| Referencia | Embalaje | Precio |
|-------------|----------|--------|
| AQ-125.7.00 | Bolsa | 3,69€ |



COCINA

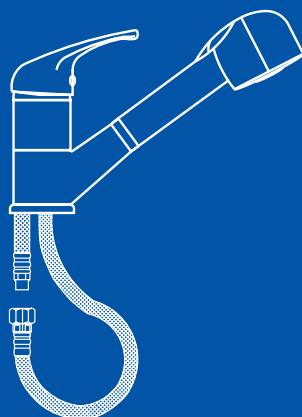
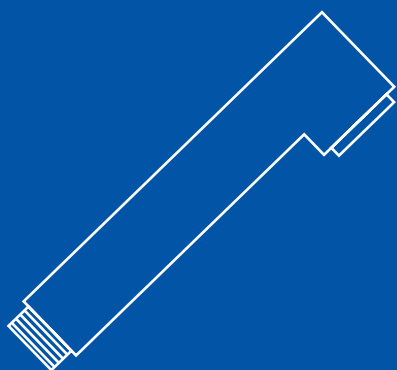

MANGO MINI SPRAY



- Cromado
- Doble cámara aislante del calor
- 1 posición



sprayer

| Referencia | Embalaje | Precio |
|-------------|--------------|---------|
| MG-490.6.00 | Bolsa solapa | 29,85 € |

Normas: ACS

Fabricación: AMFAG

MANGO MINI SPRAY NEGRO



- Negro mate
- Doble cámara aislante del calor
- 1 posición



sprayer

| Referencia | Embalaje | Precio |
|---------------|--------------|---------|
| MG-490NG.6.00 | Bolsa solapa | 48,01 € |

Normas: ACS

Fabricación: AMFAG

MANGO MINI PULL-OUT



- Cromado
- Doble cámara aislante del calor
- 2 posiciones



aerator



sprayer

| Referencia | Embalaje | Precio |
|-------------|--------------|---------|
| MG-480.6.00 | Bolsa solapa | 29,81 € |

Normas: ACS

Fabricación: AMFAG

MANGO OPTIMA



- Cromado
- Doble cámara aislante del calor
- 2 posiciones



aerator



sprayer

| Referencia | Embalaje | Precio |
|-------------|--------------|---------|
| MG-325.6.00 | Bolsa solapa | 11,73 € |

CONTRAPESO DE PLOMO



- Plomo para flexo extraíble

| Referencia | Diámetro | Embalaje | Precio |
|---------------|----------|----------|--------|
| PLOMO-12.7.00 | 12 | Bolsa | 5,74 € |
| PLOMO-14.7.00 | 14 | Bolsa | 5,78 € |

FLEXO EXTRAÍBLE DE FREGADERA



· Boquilla loca



· Tuerca cónica latón 1/2"



· Inoxidable



Ø 14



| | Referencia | Cromado | Grapado doble | Rosca | Longitud | Embalaje | Precio |
|----------------|-------------|---------|---------------|---------|----------|--------------|---------|
| Estándar doble | FL-114.6.00 | • | • | M15/100 | 1.20 m. | Bolsa solapa | 6,93 € |
| | FL-112.6.00 | • | • | M15/100 | 1.20 m. | Bolsa solapa | 12,34 € |
| M3/8 Doble | FL-115.6.00 | • | • | M3/8" | 1.50 m. | Bolsa solapa | 8,08 € |
| | FL-117.6.00 | • | • | M3/8" | 1.20 m. | Bolsa solapa | 6,64 € |
| | FL-132.6.00 | • | • | M3/8" | 1.20 m. | Bolsa solapa | 13,49 € |

Normas: ACS

FLEXO EXTRAÍBLE DE FREGADERA POLIMÉRICO



· Boquilla giratoria - Anti-torsión



· Tuerca cónica latón 1/2"



Ø 12,5

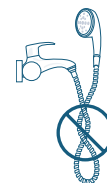

· Tubo interior PVC
· Trenzado polipropileno

| | Referencia | Rosca | Longitud | Embalaje | Precio |
|-------|-------------|---------|----------|--------------|--------|
| Negro | FL-255.6.00 | M15/100 | 1.50 m. | Bolsa solapa | 8,82 € |

FLEXO PARA GRIFO INDUSTRIAL



- Plástica
- Boquilla giratoria - Anti-torsión

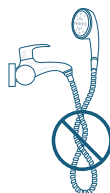

| Referencia | Rosca | Diámetro | Longitud | Embalaje | Precio |
|----------------|---------|----------|----------|----------|---------|
| CL-D10040.7.00 | HH 1/2" | 15 | 1.00 m. | Bolsa | 17,18 € |

ROCIADOR



- Cromado
- Con rótula
- 2 posiciones



| Referencia | Rosca | Embalaje | Precio |
|-------------|-------|--------------|--------|
| RC-140.2.00 | H22 | Blíster | 6,44 € |
| RC-140.6.00 | | Bolsa solapa | 6,11 € |
| RC-150.2.00 | M24 | Blíster | 6,20 € |
| RC-150.6.00 | | Bolsa solapa | 5,86 € |

● Disponible rótula (ES-176)



FONTANERÍA

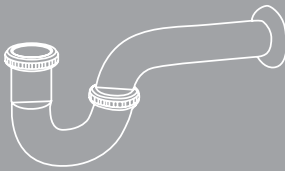

GRIFOS LAVADORA / LAVAVAJILLAS

· Cromado



| | Referencia | Rosca Entrada | Rosca Salida | Embalaje | Precio |
|----------|-------------|---------------|--------------|--------------|---------|
| SENCILLO | GF-010.7.00 | 1/2" | 3/4" | Bolsa | 13,53 € |
| | GF-010.6.00 | | | Bolsa solapa | 15,17 € |



| | | | | | |
|---|-------------|------|-------------|--------------|---------|
| DOBLE TIPO "V" LAVADORA Y LAVAVAJILLAS | GF-015.7.00 | 1/2" | 3/4" - 3/4" | Bolsa | 24,23 € |
| | GF-015.6.00 | | | Bolsa solapa | 25,87 € |



| | | | | | |
|--|-------------|------|------------------|--------------|---------|
| DOBLE LAVADORA O LAVAVAJILLAS + GRIFO | GF-020.7.00 | 1/2" | 3/4" - Sin rosca | Bolsa | 27,68 € |
| | GF-020.6.00 | | | Bolsa solapa | 29,32 € |



| | | | | | |
|----------------------------------|-------------|------|-------------|--------------|---------|
| DOBLE LAVADORA Y LAVAVAJILLAS | GF-030.7.00 | 1/2" | 3/4" - 3/4" | Bolsa | 27,32 € |
| | GF-030.6.00 | | | Bolsa solapa | 29,43 € |



| | | | | | |
|--|-------------|------|-------------|--------------|---------|
| DOBLE GRIFO Y LAVADORA/LAVAVAJILLAS ABERTURA Y CIERRE INDIVIDUAL | GF-350.7.00 | 1/2" | 3/8" - 3/4" | Bolsa | 15,29 € |
| | GF-350.6.00 | | | Bolsa solapa | 17,18 € |

GRIFOS FREGADERA

· Frontal
· Cromado
· Con rompeaguas



| | Referencia | Medida | Rosca Entrada | Embalaje | Precio |
|-------|-------------|---------|---------------|--------------|---------|
| CORTO | GF-040.7.00 | 13.5 cm | 1/2" | Bolsa | 16,55 € |
| | GF-040.6.00 | | | Bolsa solapa | 17,51 € |



| | | | | | |
|-------|-------------|-------|------|--------------|---------|
| LARGO | GF-060.7.00 | 17 cm | 1/2" | Bolsa | 21,12 € |
| | GF-060.6.00 | | | Bolsa solapa | 22,43 € |

LLAVE REGULACIÓN

- Latón
- Cromado



| | Referencia | Rosca Entrada | Rosca Salida | Embalaje | Precio |
|-------------------------------------|-------------|---------------|--------------|----------|--------|
| VERTICAL LAVADORA O LAVAVAJILLAS | GF-420.5.00 | 1/2" | 3/4" | Caja | 5,86 € |



| | | | | | |
|---------------------------------------|-------------|------|------|------|--------|
| HORIZONTAL LAVADORA O LAVAVAJILLAS | GF-100.5.00 | 1/2" | 3/4" | Caja | 3,81 € |
|---------------------------------------|-------------|------|------|------|--------|



| | | | | | |
|------------|-------------|------|------|------|--------|
| HORIZONTAL | GF-110.5.00 | 1/2" | 3/8" | Caja | 3,29 € |
| | GF-116.5.00 | | 1/2" | Caja | 3,65 € |



| | | | | | |
|---------------------|---------------|------|------|------|--------|
| NEGRO HORIZONTAL | GF-112NG.5.00 | 1/2" | 3/8" | Caja | 7,42 € |
| | GF-113NG.5.00 | | 1/2" | Caja | 7,51 € |



| | | | | | |
|--------------------------|-------------|------|------|------|--------|
| HORIZONTAL CON TUERCA | GF-120.5.00 | 1/2" | 3/8" | Caja | 6,07 € |
|--------------------------|-------------|------|------|------|--------|



| | | | | | |
|--------------------|-------------|------|------|------|--------|
| HORIZONTAL LUJO | GF-112.5.00 | | 3/8" | Caja | 5,45 € |
| | GF-113.5.00 | 1/2" | 1/2" | Caja | 5,54 € |
| | GF-117.5.00 | | 3/4" | Caja | 5,76 € |



Componentes

| | | | | | |
|-------------------------|-----|--|------|--------|--------|
| ❶ TUERCA Y BICONO CORTO | 610 | | 3/8" | Granel | 1,38 € |
|-------------------------|-----|--|------|--------|--------|

LLAVE REGULACIÓN HORIZONTAL



Horizontal
Acero Inoxidable 304

| Referencia | Rosca Entrada | Rosca Salida | Embalaje | Precio |
|---------------|---------------|--------------|----------|--------|
| GF-100AC.5.00 | 1/2" | 3/4" | Caja | 7,56 € |
| GF-110AC.5.00 | 1/2" | 3/8" | Caja | 6,73 € |
| GF-116AC.5.00 | 1/2" | 1/2" | Caja | 6,93 € |

LLAVE REGULACIÓN COMBI



1/4 de vuelta
Acero Inoxidable 304
Lavadora o lavavajillas

| Referencia | Rosca | Embalaje | Precio |
|---------------|--------------------|----------|---------|
| GF-350AC.5.00 | 3/8" x 1/2" x 3/4" | Caja | 14,24 € |
| GF-351AC.5.00 | 1/2" x 1/2" x 3/4" | | 14,24 € |



1/4 de vuelta
Acero Inoxidable 304
Lavadora o lavavajillas

| Referencia | Rosca | Embalaje | Precio |
|---------------|--------------------|----------|---------|
| GF-352AC.5.00 | 1/2" x 3/8" x 3/8" | Caja | 14,24 € |
| GF-353AC.5.00 | 1/2" x 1/2" x 1/2" | | 14,24 € |

GRIFOS MANGUERA CLASSIC

· Latón



| | Referencia | Rosca Entrada | Rosca Salida | Embalaje | Precio |
|--------------------|-------------|---------------|--------------|--------------|---------|
| SIN RACOR | GF-080.7.00 | 1/2" | Sin rosca | Bolsa | 4,55 € |
| | GF-080.6.00 | | | Bolsa solapa | 6,19 € |
| CON RACOR MANGUERA | GF-090.7.00 | 1/2" | 3/4" | Bolsa | 20,38 € |
| | GF-090.6.00 | | | Bolsa solapa | 22,02 € |

GRIFOS MANGUERA JARDÍN

· Cromado

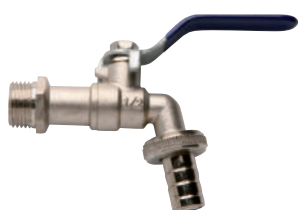

| | Referencia | Rosca Entrada | Rosca Salida | Embalaje | Precio |
|-----------------------------|-------------|---------------|--------------|----------|---------|
| RACOR MANGUERA | GF-130.0.00 | 1/2" | 3/4" | Grael | 5,88 € |
| | GF-140.0.00 | 3/4" | 1" | Grael | 8,32 € |
| ENCHUFE RÁPIDO | GF-145.0.00 | 1/2" | 3/4" | Grael | 6,32 € |
| DOBLE SALIDA ENCHUFE RÁPIDO | GF-270.7.00 | 1/2" | 3/4"-3/4" | Bolsa | 19,72 € |

Componentes

| | | | | | |
|-------------------------------|-------------|------|----------------|--------------|--------|
| RACOR MANGUERA ENCHUFE RÁPIDO | GF-146.0.00 | 3/4" | Enchufe rápido | Grael | 1,42 € |
| | GF-146.6.00 | | | Bolsa solapa | 5,96 € |

LLAVE DE PASO

· Latón



| | Referencia | Rosca Entrada | Rosca Salida | Embalaje | Precio |
|-----------------------------|-------------|---------------|--------------|----------|---------|
| HEMBRA-HEMBRA | GF-160.0.00 | 1/2" | 1/2" | Grael | 6,23 € |
| · Maneta de acero | GF-170.0.00 | 3/4" | 3/4" | | 8,94 € |
| · Temperatura máxima 120 °C | GF-180.0.00 | 1" | 1" | | 13,41 € |
| | GF-190.0.00 | 1 1/4" | 1 1/4" | | 27,55 € |
| | GF-200.0.00 | 1 1/2" | 1 1/2" | | 35,88 € |
| | GF-210.0.00 | 2" | 2" | | 76,30 € |

Válvulas



| | Referencia | Medidas | Embalaje | Precio |
|---------------------------|-------------|---------|----------|--------|
| Mini M/H | GF-360.0.00 | 1/2" | Granel | 4,84 € |
| •PN16 Latón según EN12165 | GF-355.0.00 | 3/8" | | 3,90 € |



| | Referencia | Medidas | Embalaje | Precio |
|---------------------------|-------------|---------|----------|--------|
| Mini M/H | GF-560.0.00 | 1/2" | Granel | 5,25 € |
| •PN16 Latón según EN12165 | GF-555.0.00 | 3/8" | | 3,90 € |



| | Referencia | Medidas | Embalaje | Precio |
|-----------------------------|-------------|---------|----------|---------|
| Bola mariposa M/H | GF-800.0.00 | 1/2" | Granel | 6,15 € |
| • Maneta de acero | GF-810.0.00 | 3/4" | | 9,35 € |
| • Temperatura máxima 120 °C | GF-820.0.00 | 1" | | 14,92 € |



| | Referencia | Medidas | Embalaje | Precio |
|-----------------------------|-------------|---------|----------|---------|
| Bola mariposa H/H | GF-700.0.00 | 1/2" | Granel | 5,74 € |
| • Maneta de acero | GF-710.0.00 | 3/4" | | 8,86 € |
| • Temperatura máxima 120 °C | GF-720.0.00 | 1" | | 14,02 € |



| | Referencia | Medidas | Embalaje | Precio |
|-----------------------------------|-------------|---------|----------|---------|
| Válvula de retención | GF-280.0.00 | 1/2" | Granel | 4,59 € |
| •PN16 Latón según EN12165 | GF-295.0.00 | 3/4" | | 6,40 € |
| •Montaje en horizontal y vertical | GF-300.0.00 | 1" | | 9,47 € |
| •Temperatura máxima 80 °C | GF-310.0.00 | 1 1/4" | | 14,76 € |
| | GF-320.0.00 | 1 1/2" | | 21,69 € |
| | GF-330.0.00 | 2" | | 33,42 € |



| | Referencia | Medidas | Embalaje | Precio |
|-------------------------------|-------------|---------|----------|---------|
| Válvula de retención de fondo | GF-285.0.00 | 1/2" | Granel | 5,95 € |
| •PN16 Latón según EN12165 | GF-297.0.00 | 3/4" | | 7,87 € |
| •Filtro en acero inoxidable | GF-305.0.00 | 1" | | 11,11 € |
| •Temperatura máxima 80 °C | GF-315.0.00 | 1 1/4" | | 16,95 € |
| | GF-325.0.00 | 1 1/2" | | 23,99 € |
| | GF-335.0.00 | 2" | | 36,37 € |



| | Referencia | Medidas | Embalaje | Precio |
|-------------------------|-------------|---------|----------|--------|
| Filtro válvula | FT-010.0.00 | 1/2" | Granel | 0,74 € |
| •Tamiz acero inoxidable | FT-020.0.00 | 3/4" | | 0,86 € |
| •y racor nylon | FT-030.0.00 | 1" | | 1,03 € |
| | FT-040.0.00 | 1 1/4" | | 1,27 € |
| | FT-050.0.00 | 1 1/2" | | 1,68 € |
| | FT-060.0.00 | 2" | | 2,34 € |

MONOMANDOS HIGIENICOS

· Para instalación junto al W.C.

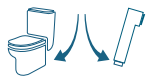

| Referencia | Rosca Entrada | Rosca Salida | Embalaje | Precio |
|-------------|---------------|---------------|----------|---------|
| GF-225.5.00 | 1/2" | M1/2" - M3/8" | Caja | 17,16 € |



MEZCLADOR DE AGUA FRÍA Y CALIENTE



| | | | | |
|-------------|--|--|------|---------|
| GF-240.5.00 | | | Caja | 55,06 € |
|-------------|--|--|------|---------|

VOLANTES

- Metálico
- 3 puntas
- Con montura universal

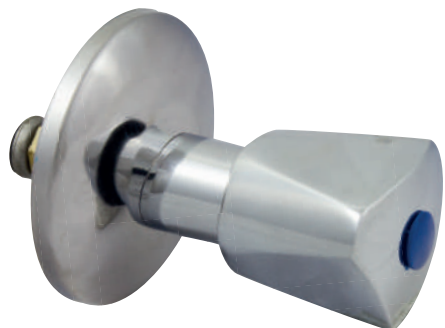

| Referencia | Rosca | Embalaje | Precio |
|------------------|--------|----------|---------|
| VISTO | | | |
| GF-380.5.00 | 16/150 | Caja | 9,23 € |
| GF-381.5.00 | 17/150 | Caja | 10,13 € |
| GF-382.5.00 | 18/150 | Caja | 9,23 € |
| GF-383.5.00 | 19/150 | Caja | 9,23 € |
| GF-384.5.00 | 20/150 | Caja | 9,59 € |
| GF-385.5.00 | 21/150 | Caja | 9,59 € |
| GF-386.5.00 | 22/150 | Caja | 9,59 € |
| GF-387.5.00 | 3/8" | Caja | 9,59 € |
| GF-388.5.00 | 1/2" | Caja | 9,59 € |
| EMPOTRADO | | | |
| GF-390.5.00 | 16/150 | Caja | 10,78 € |
| GF-391.5.00 | 17/150 | Caja | 11,93 € |
| GF-392.5.00 | 18/150 | Caja | 10,78 € |
| GF-393.5.00 | 19/150 | Caja | 12,26 € |
| GF-394.5.00 | 20/150 | Caja | 10,78 € |
| GF-395.5.00 | 21/150 | Caja | 12,26 € |
| GF-396.5.00 | 22/150 | Caja | 10,78 € |
| GF-397.5.00 | 3/8" | Caja | 11,93 € |
| GF-398.5.00 | 1/2" | Caja | 13,08 € |

GRIFOS FREGADERA

- Cromado
- Empotrable a la pared
- Entrada Hembra 3/4" con excéntrica



| | Referencia | Embalaje | Precio |
|--------|-------------|----------|---------|
| 1 AGUA | GF-430.5.00 | Caja | 38,99 € |



| | | | |
|------------------------------|-------------|------|---------|
| BATERÍA BIMANDO Caño alto | GF-440.5.00 | Caja | 69,37 € |
|------------------------------|-------------|------|---------|



| | | | |
|---------------------------------------|-------------|------|---------|
| BATERÍA BIMANDO ESTÁNDAR Caño alto | GF-450.5.00 | Caja | 75,75 € |
|---------------------------------------|-------------|------|---------|

KIT 2 EXCÉNTRICAS CON 2 FLORONES

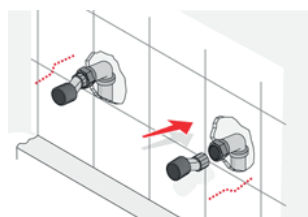

- Rosca entrada 1/2"
- Roca salida 3/4"



| | Referencia | Desplazamiento | Diámetro | Embalaje | Precio |
|---------|-------------|----------------|----------|--------------|---------|
| CROMADO | AF-236.7.00 | | | Bolsa | 9,72 € |
| | AF-236.6.00 | 1,5 cm | 6,5 cm | Bolsa solapa | 11,36 € |
| | AF-237.7.00 | | | Bolsa | 13,94 € |
| | AF-237.6.00 | 2,5 cm | 8,0 cm | Bolsa solapa | 16,58 € |
| | AF-230.7.00 | | | Bolsa | 34,28 € |
| | AF-230.6.00 | 3 cm | 12,5 cm | Bolsa solapa | 35,92 € |

FABRICACIÓN NACIONAL

Diseñados, desarrollados y fabricados en nuestras propias instalaciones con las máximas exigencias normativas, pruebas de los límites de presión, temperaturas de funcionamiento, medidas de caudal, resistencia a la tracción, etc., de los materiales y las capacidades. No dude en ponerse en contacto con nosotros. Esperamos poder ayudarle con nuestra experiencia y conocimientos técnicos.

FABRICACIÓN EN CUALQUIER LONGITUD

Nuestra experiencia en conectores flexibles nos permite tener conocimiento para el desarrollo de nuevas soluciones y requisitos específicos de la industria.

Contamos con un equipo de fabricación dedicado exclusivamente a conectores flexibles, que reducirán los riesgos de diseño y desarrollo y acortarán el plazo de comercialización.



CONEXIONES INOXIDABLES

- Cromado
- Diámetro 8 x 12

❗ Solicitar información para conexiones de Ø10 y Ø15 para conexiones plastificadas



| Longitud | Rosca | | | | | | | Embalaje |
|----------|-------------|---------------|-------------|-------------|---------------|-------------|---------------|--------------|
| | MH 1/2" | M1/2" - H3/8" | HH 1/2" | HH 3/8" | H1/2" - H3/8" | MH 3/8" | M3/8" - H1/2" | |
| 15 cm | CX-151.7.00 | CX-152.7.00 | CX-153.7.00 | CX-154.7.00 | CX-155.7.00 | CX-156.7.00 | CX-157.7.00 | Bolsa 10 ud. |
| | 2,28 € | 2,15 € | 2,23 € | 1,97 € | 2,10 € | 2,02 € | 2,16 € | |
| | CX-151.2.00 | CX-152.2.00 | CX-153.2.00 | CX-154.2.00 | CX-155.2.00 | CX-156.2.00 | CX-157.2.00 | Solapado |
| | 3,20 € | 3,07 € | 3,15 € | 2,89 € | 3,02 € | 2,94 € | 3,08 € | |
| 20 cm | CX-201.7.00 | CX-202.7.00 | CX-203.7.00 | CX-204.7.00 | CX-205.7.00 | CX-206.7.00 | CX-207.7.00 | Bolsa 10 ud. |
| | 2,42 € | 2,32 € | 2,32 € | 2,06 € | 2,19 € | 2,18 € | 2,24 € | |
| | CX-201.2.00 | CX-202.2.00 | CX-203.2.00 | CX-204.2.00 | CX-205.2.00 | CX-206.2.00 | CX-207.2.00 | Solapado |
| | 3,29 € | 3,16 € | 3,24 € | 2,98 € | 3,11 € | 3,04 € | 3,16 € | |
| 25 cm | CX-251.7.00 | CX-252.7.00 | CX-253.7.00 | CX-254.7.00 | CX-255.7.00 | CX-256.7.00 | CX-257.7.00 | Bolsa 10 ud. |
| | 2,49 € | 2,48 € | 2,42 € | 2,15 € | 2,28 € | 2,26 € | 2,34 € | |
| | CX-251.2.00 | CX-252.2.00 | CX-253.2.00 | CX-254.2.00 | CX-255.2.00 | CX-256.2.00 | CX-257.2.00 | Solapado |
| | 3,39 € | 3,25 € | 3,34 € | 3,07 € | 3,20 € | 3,13 € | 3,26 € | |
| 30 cm | CX-301.7.00 | CX-302.7.00 | CX-303.7.00 | CX-304.7.00 | CX-305.7.00 | CX-306.7.00 | CX-307.7.00 | Bolsa 10 ud. |
| | 2,56 € | 2,48 € | 2,51 € | 2,28 € | 2,37 € | 2,30 € | 2,43 € | |
| | CX-301.2.00 | CX-302.2.00 | CX-303.2.00 | CX-304.2.00 | CX-305.2.00 | CX-306.2.00 | CX-307.2.00 | Solapado |
| | 3,48 € | 3,34 € | 3,43 € | 3,16 € | 3,29 € | 3,22 € | 3,35 € | |
| 35 cm | CX-351.7.00 | CX-352.7.00 | CX-353.7.00 | CX-354.7.00 | CX-355.7.00 | CX-356.7.00 | CX-357.7.00 | Bolsa 10 ud. |
| | 2,75 € | 2,52 € | 2,60 € | 2,44 € | 2,47 € | 2,39 € | 2,53 € | |
| | CX-351.2.00 | CX-352.2.00 | CX-353.2.00 | CX-354.2.00 | CX-355.2.00 | CX-356.2.00 | CX-357.2.00 | Solapado |
| | 3,57 € | 3,44 € | 3,52 € | 3,26 € | 3,39 € | 3,31 € | 3,45 € | |
| 40 cm | CX-401.7.00 | CX-402.7.00 | CX-403.7.00 | CX-404.7.00 | CX-405.7.00 | CX-406.7.00 | CX-407.7.00 | Bolsa 10 ud. |
| | 2,94 € | 2,71 € | 2,69 € | 2,53 € | 2,56 € | 2,58 € | 2,62 € | |
| | CX-401.2.00 | CX-402.2.00 | CX-403.2.00 | CX-404.2.00 | CX-405.2.00 | CX-406.2.00 | CX-407.2.00 | Solapado |
| | 3,66 € | 3,53 € | 3,61 € | 3,35 € | 3,48 € | 3,40 € | 3,54 € | |
| 50 cm | CX-501.7.00 | CX-502.7.00 | CX-503.7.00 | CX-504.7.00 | CX-505.7.00 | CX-506.7.00 | CX-507.7.00 | Bolsa 10ud. |
| | 3,02 € | 2,80 € | 2,88 € | 2,71 € | 2,74 € | 2,67 € | 2,80 € | |
| | CX-501.2.00 | CX-502.2.00 | CX-503.2.00 | CX-504.2.00 | CX-505.2.00 | CX-506.2.00 | CX-507.2.00 | Solapado |
| | 3,85 € | 3,72 € | 3,80 € | 3,53 € | 3,66 € | 3,59 € | 3,72 € | |

CONEXIONES INOXIDABLES

- Cromado
- Diámetro 8 x 12

❗ Solicitar información para conexiones de Ø10 y Ø15 para conexiones plastificadas

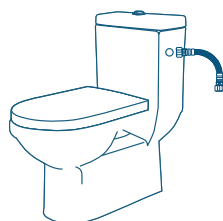

| Longitud | Rosca | | | | | | | Embalaje |
|----------|--------------|---------------|--------------|--------------|---------------|--------------|---------------|--------------|
| | MH 1/2" | M1/2" - H3/8" | HH 1/2" | HH 3/8" | H1/2" - H3/8" | MH 3/8" | M3/8" - H1/2" | |
| 60 cm | CX-601.7.00 | CX-602.7.00 | CX-603.7.00 | CX-604.7.00 | CX-605.7.00 | CX-606.7.00 | CX-607.7.00 | Bolsa 10 ud. |
| | 2,99 € | 2,98 € | 3,26 € | 2,80 € | 3,11 € | 3,05 € | 3,06 € | |
| 60 cm | CX-601.2.00 | CX-602.2.00 | CX-603.2.00 | CX-604.2.00 | CX-605.2.00 | CX-606.2.00 | CX-607.2.00 | Solapado |
| | 3,91 € | 3,90 € | 3,98 € | 3,72 € | 3,85 € | 3,77 € | 3,91 € | |
| 70 cm | CX-701.7.00 | CX-702.7.00 | CX-703.7.00 | CX-704.7.00 | CX-705.7.00 | CX-706.7.00 | CX-707.7.00 | Bolsa 10 ud. |
| | 4,48 € | 3,21 € | 3,24 € | 2,98 € | 3,11 € | 3,04 € | 3,17 € | |
| 80 cm | CX-801.7.00 | CX-802.7.00 | CX-803.7.00 | CX-804.7.00 | CX-805.7.00 | CX-806.7.00 | CX-807.7.00 | Bolsa 10 ud. |
| | 3,68 € | 3,56 € | 3,92 € | 3,37 € | 3,50 € | 3,42 € | 3,55 € | |
| 90 cm | CX-901.7.00 | CX-902.7.00 | CX-903.7.00 | CX-904.7.00 | CX-905.7.00 | CX-906.7.00 | CX-907.7.00 | Bolsa 10 ud. |
| | 3,86 € | 3,73 € | 3,81 € | 4,01 € | 3,68 € | 3,61 € | 3,74 € | |
| 100 cm | CX-1001.7.00 | CX-1002.7.00 | CX-1003.7.00 | CX-1004.7.00 | CX-1005.7.00 | CX-1006.7.00 | CX-1007.7.00 | Bolsa 10 ud. |
| | 4,05 € | 3,91 € | 4,00 € | 3,74 € | 3,86 € | 3,79 € | 3,92 € | |

CONEXIONES GRIFERÍA

- Cromado
- Diámetro 8 x 12

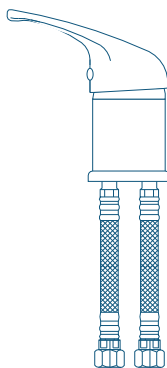

 Fabricación con codo 1/2"
  Fabricación con codo 3/8"

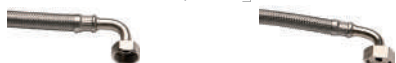

| Longitud | Rosca | | Embalaje |
|----------|------------------------|------------------------|----------------------------------|
| | M10/100 - H3/8" | M10/100 - H1/2" | |
| 30 cm | CG-3001.7.00 2,10 € | CG-3002.7.00 3,10 € | Bolsa 10ud (Precio x unidad) |
| | CG-3001.2.00 3,04 € | CG-3002.2.00 3,98 € | Solapado |
| 35 cm | CG-3501.7.00 2,14 € | CG-3502.7.00 3,25 € | Bolsa 10 ud (Precio x unidad) |
| | CG-3501.2.00 3,13 € | CG-3502.2.00 4,18 € | Solapado |
| 35 cm | CG-3506.7.00 2,14 € | | Bolsa 10 ud (Precio x unidad) |
| | CG-3506.2.00 4,00 € | | Solapado |
| 40 cm | CG-4001.7.00 2,29 € | | Bolsa 10 ud (Precio x unidad) |
| | CG-4001.2.00 3,23 € | | Solapado |

CONEXIONES LUJO NEGRAS

- Con funda de latón
- Negro mate
- Diámetro 15



| Longitud | Rosca | | Embalaje |
|----------|----------------------------|--|--------------------|
| | HH 3/8" | | |
| 25 cm | CXF-254NG.6.00 29,96 € | | Bolsa solapa |
| 30 cm | CXF-304NG.6.00 27,66 € | | Bolsa solapa |
| 35 cm | CXF-354NG.6.00 27,93 € | | Bolsa solapa |
| 35 cm | CXF-3501NG.6.00 50,25 € | | Bolsa solapa (2ud) |

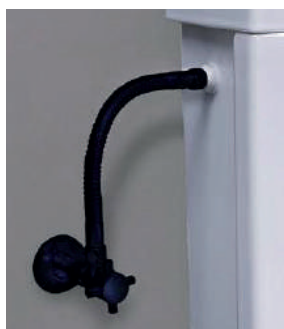

CONEXIONES RÍGIDAS

- Cobre
- Cromado

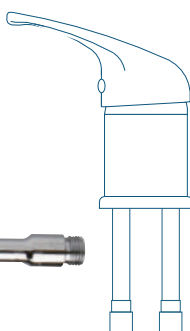

| Referencia | Rosca | | Embalaje | Precio |
|------------|----------|---------------|----------|--------|
| | Longitud | M10/100-H3/8 | | |
| | 13,5 cm | CG-AL135.0.00 | Granel | 7,75 € |
| | 27,0 cm | CG-AL270.0.00 | Granel | 8,01 € |

CONEXIONES INOXIDABLES PARA CALENTADORES Y CALDERAS

- Cromado
- Diámetro 13 x 19

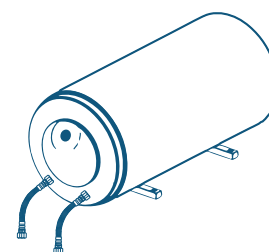

| Longitud | Rosca | | | | | | | Embalaje |
|----------|-------------|---------------|-------------|-------------|---------------|-------------|--------------|----------|
| | MH 1/2" | M1/2" - H3/4" | HH 1/2" | HH 3/4" | H1/2" - H3/4" | MH 3/4" | M3/4 - H1/2" | |
| 20 cm. | CS-206.0.00 | CS-207.0.00 | CS-204.0.00 | CS-203.0.00 | CS-205.0.00 | CS-201.0.00 | CS-202.0.00 | Granel |
| | 4,85 € | 5,84 € | 4,85 € | 6,34 € | 5,63 € | 6,55 € | 5,79 € | |
| 25 cm. | CS-256.0.00 | CS-257.0.00 | CS-254.0.00 | CS-253.0.00 | CS-255.0.00 | CS-251.0.00 | CS-252.0.00 | Granel |
| | 5,15 € | 6,10 € | 5,04 € | 6,56 € | 5,83 € | 6,85 € | 6,08 € | |
| 30 cm. | CS-306.0.00 | CS-307.0.00 | CS-304.0.00 | CS-303.0.00 | CS-305.0.00 | CS-301.0.00 | CS-302.0.00 | Granel |
| | 5,45 € | 6,22 € | 5,30 € | 6,92 € | 6,07 € | 7,01 € | 6,22 € | |
| 35 cm. | CS-356.0.00 | CS-357.0.00 | CS-354.0.00 | CS-353.0.00 | CS-355.0.00 | CS-351.0.00 | CS-352.0.00 | Granel |
| | 6,32 € | 6,52 € | 6,61 € | 7,14 € | 6,39 € | 8,07 € | 6,70 € | |
| 40 cm. | CS-406.0.00 | CS-407.0.00 | CS-404.0.00 | CS-403.0.00 | CS-405.0.00 | CS-401.0.00 | CS-402.0.00 | Granel |
| | 6,36 € | 6,84 € | 5,91 € | 8,03 € | 6,66 € | 8,33 € | 7,00 € | |
| 50 cm. | CS-506.0.00 | CS-507.0.00 | CS-504.0.00 | CS-503.0.00 | CS-505.0.00 | CS-501.0.00 | CS-502.0.00 | Granel |
| | 7,12 € | 8,01 € | 6,96 € | 8,10 € | 8,37 € | 8,41 € | 7,61 € | |
| 60 cm. | CS-606.0.00 | CS-607.0.00 | CS-604.0.00 | CS-603.0.00 | CS-605.0.00 | CS-601.0.00 | CS-602.0.00 | Granel |
| | 7,27 € | 8,24 € | 7,13 € | 9,10 € | 8,10 € | 9,16 € | 8,22 € | |
| 70 cm. | CS-706.0.00 | CS-707.0.00 | CS-704.0.00 | CS-703.0.00 | CS-705.0.00 | CS-701.0.00 | CS-702.0.00 | Granel |
| | 7,88 € | 8,71 € | 7,73 € | 9,34 € | 8,56 € | 9,60 € | 8,82 € | |
| 80 cm. | CS-806.0.00 | CS-807.0.00 | CS-804.0.00 | CS-803.0.00 | CS-805.0.00 | CS-801.0.00 | CS-802.0.00 | Granel |
| | 8,49 € | 9,56 € | 8,33 € | 10,32 € | 9,29 € | 10,21 € | 9,43 € | |

Disponibilidad bolsa solapa



CONEXIONES PARA BOMBAS INDUSTRIALES

- Acero galvanizado
- Cromado

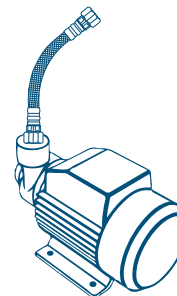

| Referencia | Longitud | Rosca | | | | | Diámetro | Embalaje | Precio |
|------------|----------|--------------|--------------|--------------|--------------|--------------|----------|----------|----------|
| | | MH 3/4" | MH 1" | MH 1" 1/4 | MH 1" 1/2 | MH 2" | | | |
| 30 cm. | | CP-B300.0.00 | | | | | 20 x 28 | Granel | 17,74 € |
| | | | CP-C300.0.00 | | | | 25 x 34 | | 24,65 € |
| | | | | CP-D300.0.00 | | | 32 x 24 | | 57,35 € |
| | | | | | CP-E300.0.00 | | 40 x 52 | | 83,15 € |
| | | | | | | CP-F300.0.00 | 50 x 62 | | 120,24 € |
| 50 cm. | | CP-B500.0.00 | | | | | 20 x 28 | Granel | 21,84 € |
| | | | CP-C500.0.00 | | | | 25 x 34 | | 28,44 € |
| | | | | CP-D500.0.00 | | | 32 x 24 | | 59,09 € |
| | | | | | CP-E500.0.00 | | 40 x 52 | | 98,63 € |
| 60 cm. | | | | | | CP-F500.0.00 | 50 x 62 | Granel | 144,10 € |
| | | CP-B600.0.00 | | | | | 20 x 28 | | 23,39 € |
| | | | CP-C600.0.00 | | | | 25 x 34 | | 29,88 € |
| | | | | CP-D600.0.00 | | | 32 x 24 | | 62,57 € |
| | | | | | CP-E600.0.00 | | 40 x 52 | | 106,26 € |
| 80 cm. | | | | | | CP-F600.0.00 | 50 x 62 | Granel | 155,87 € |
| | | CP-B800.0.00 | | | | | 20 x 28 | | 26,42 € |
| | | | CP-C800.0.00 | | | | 25 x 34 | | 34,21 € |
| | | | | CP-D800.0.00 | | | 32 x 24 | | 85,34 € |
| | | | | | CP-E800.0.00 | | 40 x 52 | | 122,02 € |
| | | | | | CP-F800.0.00 | 50 x 62 | 159,50 € | | |

CONEXIONES PARA BATERÍA DE CONTADORES

- Acero Inoxidable

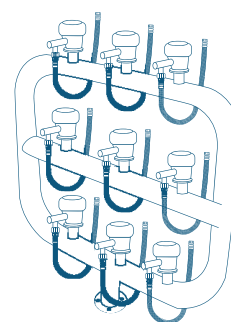

| Referencia | Longitud | Rosca | | | | Diámetro | Embalaje | Precio |
|------------|----------|---------------|---------------|-------|---------------|----------|----------|---------------|
| | | MH 3/4" | HH 3/4" | MH 1" | HH 1" | | | |
| 50 cm. | | CP-BI501.0.00 | | | | 20 x 28 | Granel | 21,84 € |
| | | | CP-BI503.0.00 | | | | | 21,84 € |
| | | | | | CP-CI501.0.00 | 25 x 34 | | 28,44 € |
| | | | | | | | | CP-CI503.0.00 |
| 60 cm. | | CP-BI601.0.00 | | | | 20 x 28 | Granel | 23,75 € |
| | | | CP-BI603.0.00 | | | | | 23,75 € |
| | | | | | CP-CI601.0.00 | 25 x 34 | | 30,34 € |
| | | | | | | | | CP-CI603.0.00 |

BOYAS



| | Referencia | Medida | Rosca | Embalaje | Precio |
|----------------------------|--------------|--------|---------------------------|----------|----------|
| ESFÉRICA · Latón | BL-090.0.00 | Ø 9 | 3/8" R3/16 | Ganel | 17,47 € |
| | BL-110.0.00 | Ø 11 | 1/2" R6/100 | Ganel | 22,14 € |
| | BL-130.0.00 | Ø 13 | 3/4" R7/100 | Ganel | 24,89 € |
| | BL-150.0.00 | Ø 15 | 1" R8/100 | Ganel | 26,49 € |
| ESFÉRICA · Cobre | BL-180.0.00 | Ø18 | 1.1/4" R9/100 | Ganel | 47,19 € |
| | BL-200.0.00 | Ø 20 | 1.1/2" R9/100 | Ganel | 51,17 € |
| | BL-230.0.00 | Ø 23 | 2" R9/100 | Ganel | 61,99 € |
| PLANA CORREDERA · Cobre | BC-120.0.00 | Ø 12 | 1/2" | Ganel | 40,92 € |
| | BC-150.0.00 | Ø 15 | 3/4" | Ganel | 40,92 € |
| | BC-170.0.00 | Ø 17 | 1" | Ganel | 53,87 € |
| | BC-200.0.00 | Ø 20 | 1.1/4" | Ganel | 57,03 € |
| | BC-230.0.00 | Ø 23 | 1.1/2" | Ganel | 64,78 € |
| | BC-250.0.00 | Ø 25 | 2" | Ganel | 71,71 € |
| | BC-280.0.00 | Ø 28 | 2.1/2" | Ganel | 98,93 € |
| | BC-300.0.00 | Ø 30 | 3" | Ganel | 114,60 € |
| | BC-400.0.00 | Ø 40 | 4" | Ganel | 961,86 € |
| PLANA · Plástico | BP-120P.0.00 | Ø 12 | 1/2" R6/100 | Ganel | 7,26 € |
| | BP-121P.0.00 | Ø 12 | 1/2" R7/100 | Ganel | 7,26€ |
| | BP-150P.0.00 | Ø 15 | 3/4" R8/100 | Ganel | 8,41 € |
| | BP-200P.0.00 | Ø 20 | 1" y 1.1/4" R9/100 | Ganel | 12,18 € |
| | BP-250P.0.00 | Ø 25 | 2" R9/100 | Ganel | 15,29 € |
| POREXPÁN AUTORROSCABLE | BP-009.0.00 | Ø 9 | 3/8" R3/16 | Ganel | 1,19 € |
| | BP-011.0.00 | Ø 11 | 1/2" R6/100 | Ganel | 1,85 € |
| | BP-016.0.00 | Ø 16 | 3/4" y 1" R6/100 | Ganel | 2,91 € |
| PLÁSTICO EXPANDIDA | BP-090.0.00 | Ø 9 | 3/8" R3/16 | Ganel | 1,56 € |
| | BP-110.0.00 | Ø 11 | 1/2" R6/100 | Ganel | 3,03 € |
| | BP-130.0.00 | Ø 13 | 3/4" R7/100 | Ganel | 3,28 € |
| | BP-150.0.00 | Ø 15 | 1" R8/100 | Ganel | 4,51 € |
| | BP-200.0.00 | Ø 20 | 1.1/4" y 1.1/2" R9/100 | Ganel | 6,60 € |
| | BP-230.0.00 | Ø 23 | 2" R9/100 | Ganel | 8,61 € |

FLOTADORES



GUÍA
 · Con asiento anticorrosivo
 · Para boya esférica

GUÍA VARILLA DESLIZANTE
 · Con asiento anticorrosivo
 · Para boya plana deslizante



FLOTADOR CISTERNA + BOYA



| | Referencia | Rosca | Embalaje | Precio | |
|--|----------------|--------------------|------------------------------|-----------------|--------|
| GUÍA · Con asiento anticorrosivo · Para boya esférica | FG-010.0.00 | 3/8" R3/16 | Grael | 12,83 € | |
| | FG-020.0.00 | 1/2" R6/100 | Grael | 14,88 € | |
| | FG-030.0.00 | 3/4" R7/100 | Grael | 24,68 € | |
| | FG-040.0.00 | 1" R8/100 | Grael | 34,19 € | |
| | FG-050.0.00 | 1.1/4" R9/100 | Grael | 64,37 € | |
| | FG-060.0.00 | 1.1/2" R9/100 | Grael | 85,85 € | |
| | FG-070.0.00 | 2" R9/100 | Grael | 129,60 € | |
| GUÍA VARILLA DESLIZANTE · Con asiento anticorrosivo · Para boya plana deslizante | FG-080.0.00 | 1/2" | Grael | 19,43 € | |
| | FG-090.0.00 | 3/4" | Grael | 29,27 € | |
| | FG-100.0.00 | 1" | Grael | 29,77 € | |
| | FG-110.0.00 | 1.1./4" | Grael | 100,57 € | |
| | FG-120.0.00 | 1.1./2" | Grael | 92,54 € | |
| | FG-130.0.00 | 2" | Grael | 159,57 € | |
| | FG-140.0.00 | Medio racor 2.1/2" | Grael | 393,31 € | |
| | FG-150.0.00 | Medio racor 3" | Grael | 613,08 € | |
| FG-154.0.00 | Medio racor 4" | Grael | 2.694,13 € | | |
| FLOTADOR CISTERNA + BOYA | FG-161.0.00 | 3/8" R3/16 | Silencioso Tanque alto | Bolsa solapa | 9,92 € |

VÁLVULAS PVC

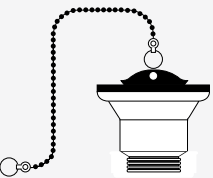
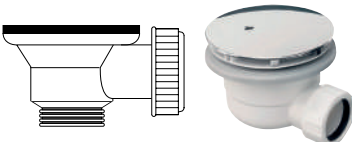
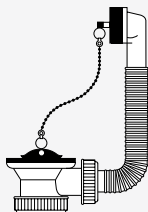
| | | Referencia | Rosca | Diámetro | Embalaje | Precio |
|---|--|-------------|--------|----------|----------|---------|
|  | VÁLVULA COCINA | SF-390.7.00 | 1.1/2" | 115 mm. | Bolsa | 10,99 € |
|  | VÁLVULA COCINA + TAPÓN + CADENILLA | SF-310.7.00 | 1.1/2" | 80 mm. | Bolsa | 5,21 € |
|  | VÁLVULA PLANA PLATO DE DUCHA | SF-360.7.00 | 1.1/2" | 85 mm. | Bolsa | 13,17 € |
| | | SF-370.7.00 | 1.1/2" | 115 mm. | Bolsa | 22,55 € |
|  | VÁLVULA + TAPÓN CON REBOSADERO REDONDO + CADENILLA | SF-320.7.00 | 1.1/2" | 80 mm. | Bolsa | 5,41 € |

PLAFONES

| | | Referencia | Diámetro EXTERIOR | Diámetro INTERIOR | Embalaje | Precio |
|---|---------------------------|------------|-------------------|-------------------|----------------------|--------|
|  | PLAFON-030.6.00 | | | 1/4" | Bolsa solapa (2 und) | 2,06 € |
| | PLAFON-035.6.00 | | | 3/8" | Bolsa solapa (2 und) | 2,06 € |
| | PLAFON-040.6.00 | | 60cm | 1/2" | Bolsa solapa (2 und) | 2,06 € |
| | PLAFON-050.6.00 | | | 1 1/4" | Bolsa solapa (2 und) | 2,06 € |
| | PLAFON-060.6.00 (CROMADO) | | | | Bolsa solapa (2 und) | 2,40 € |

SIFONES PVC

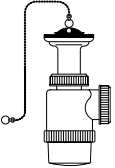
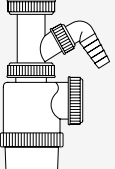
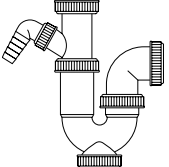
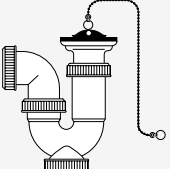
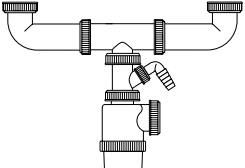
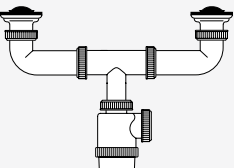
| | Referencia | Rosca | Diámetro | Embalaje | Precio |
|---|--|--------|----------|----------|---------|
|  | SIFÓN BOTELLA EXTENSIBLE CON VÁLVULA Y CADENILLA SF-210.7.00 | 1.1/2" | 70 mm. | Bolsa | 7,87 € |
|  | SIFÓN BOTELLA CON TOMA LAVAVAJILLAS SF-220.7.00 | 1.1/2" | - | Bolsa | 6,40 € |
|  | SIFÓN CURVO EXTENSIBLE CON TOMA DE LAVAVAJILLAS SF-230.7.00 | 1.1/2" | - | Bolsa | 7,50 € |
|  | SIFÓN CURVO EXTENSIBLE RÍGIDO CON VÁLVULA Y CADENILLA SF-240.7.00 | 1.1/2" | 70 mm. | Bolsa | 9,35 € |
|  | SIFÓN DOBLE EXTENSIBLE CON TOMA DE LAVAVAJILLAS SF-270.7.00 | 1.1/2" | - | Bolsa | 7,43 € |
|  | SIFÓN DOBLE EXTENSIBLE CON VÁLVULA SF-280.7.00 | 1.1/2" | 70 mm. | Bolsa | 15,38 € |

SIFONES EXTENSIBLES

· 30 a 70 cm.



| | Referencia | Medida | Embalaje | Precio |
|--------|-------------|----------------|----------|--------|
| BLANCO | SF-150.7.00 | 1.1/2" - 32/40 | Bolsa | 2,52 € |
| | SF-160.7.00 | 1.1/4" - 32/40 | Bolsa | 2,46 € |

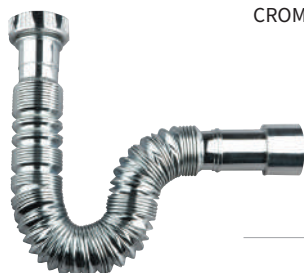

| | | | | |
|---------|-------------|----------------|-------|--------|
| CROMADO | SF-170.7.00 | 1.1/2" - 32/40 | Bolsa | 8,12 € |
| | SF-180.7.00 | 1.1/4" - 32/40 | Bolsa | 7,77 € |

SIFONES EXTENSIBLES CON VÁLVULA CLIC-CLAC

· 1.1/2" x 32/40



BLANCO

| Referencia | Medida | Embalaje | Precio |
|-------------|----------------|----------|---------|
| SF-155.0.00 | 1.1/2" - 32/40 | Granel | 15,58 € |

CROMADO



| | | | |
|-------------|----------------|--------|---------|
| SF-175.0.00 | 1.1/2" - 32/40 | Granel | 17,59 € |
|-------------|----------------|--------|---------|

ALARGO PARA SIFÓN



| Referencia | Medida | Embalaje | Precio |
|------------|---------------|----------|--------|
| PL-25.7.00 | 32/40 - 32/40 | Bolsa | 2,17 € |

REDUCTOR SIFÓN



· Cromado
· Largo 25 cm
· Diámetro 32

| Referencia | Medida | Embalaje | Precio |
|-------------|-------------------|----------|--------|
| SF-135.7.00 | H1.1/4" - M1.1/2" | Bolsa | 1,15 € |
| SF-136.7.00 | H1.1/2" - M1.1/4" | Bolsa | 1,23 € |

TUBO ALARGO PARA SIFÓN



NOVEDAD



| Referencia | Material | Embalaje | Precio |
|---------------|------------|--------------|---------|
| AF-301.6.00 | Cromado | Bolsa solapa | 9,88 € |
| AF-301NG.6.00 | Negro mate | Bolsa solapa | 21,85 € |

· Largo 25 cm
· Diámetro 32

TUBO ALARGO CON PESTAÑA PARA SIFÓN



NOVEDAD



| Referencia | Material | Embalaje | Precio |
|---------------|------------|----------|---------|
| AF-302.0.00 | Cromada | Grael | 11,21 € |
| AF-302NG.0.00 | Negro mate | Grael | 19,60 € |

- Largo 30 cm
- Diámetro 32

SIFONES METÁLICOS



| | Referencia | Medida | Material | Embalaje | Precio |
|--------|-------------|----------------|----------|----------|---------|
| SIMPLE | AF-300.5.00 | 1.1/4" x 30/32 | Metálico | Caja | 18,69 € |

- Cromado



| | | | | | |
|--------------|-------------|----------------|----------|------|---------|
| LUJO REDONDO | AF-370.5.00 | 1.1/4" x 30/32 | Metálico | Caja | 34,72 € |
|--------------|-------------|----------------|----------|------|---------|

- Cromado



| | | | | | |
|--------------|---------------|----------------|----------------|------|---------|
| LUJO REDONDO | AF-370NG.5.00 | 1.1/4" x 30/32 | Metálico negro | Caja | 46,70 € |
|--------------|---------------|----------------|----------------|------|---------|

- Negro mate



| | | | | | |
|---------------|-------------|----------------|----------|------|---------|
| LUJO CUADRADO | AF-380.5.00 | 1.1/4" x 30/32 | Metálico | Caja | 54,98 € |
|---------------|-------------|----------------|----------|------|---------|

- Cromado

VÁLVULAS CLIC-CLAC



NOVEDAD



| | Referencia | Embalaje | Precio |
|---|----------------------|----------|----------------|
| CROMADA GIRATORIA · Para lavabo o bidé · Universal - Rosca 1.1/4" G | AF-332.5.00 | Caja | 15,67 € |
| CROMADA - SETA PEQUEÑA · Para lavabo o bidé · Universal - Rosca 1.1/4" G | AF-334.5.00 | Caja | 17,55 € |
| CROMADA - SETA GRANDE · Para lavabo o bidé · Universal - Rosca 1.1/4" G | AF-335.5.00 | Caja | 15,82 € |
| CROMADA - SETA DE PORCELANA BLANCA · Para lavabo o bidé · Universal - Rosca 1.1/4" G | AF-345.5.00 | Caja | 19,11 € |
| COBRE · Para lavabo o bidé · Universal - Rosca 1.1/4" G | AF-336C.5.00 | Caja | 21,41 € |
| LATÓN VIEJO · Para lavabo o bidé · Universal - Rosca 1.1/4" G | AF-336L.5.00 | Caja | 21,41 € |
| NEGRO · Para lavabo o bidé · Universal - Rosca 1.1/4" G | AF-335NG.5.00 | Caja | 21,79 € |
| CROMADA - SETA PEQUEÑA · Para lavabo o bidé · Universal - Rosca 1.1/4" G · Cuerpo corto | AF-334CT.5.00 | Caja | 13,11 € |
| CROMADA - SETA GRANDE · Para lavabo o bidé · Universal - Rosca 1.1/4" G · Cuerpo corto | AF-335CT.5.00 | Caja | 14,12 € |

TAPONES



LAVABO
· Simple

| Referencia | Medida | Embalaje | Precio |
|------------|----------|--------------|--------|
| TP-32.0.00 | Ø 32 mm. | Grael | 0,74 € |
| TP-32.6.00 | | Bolsa solapa | 1,76 € |
| TP-34.0.00 | Ø 34 mm. | Grael | 0,78 € |
| TP-34.6.00 | | Bolsa solapa | 1,80 € |
| TP-36.0.00 | Ø 36 mm. | Grael | 0,78 € |
| TP-36.6.00 | | Bolsa solapa | 1,80 € |
| TP-38.0.00 | Ø 38 mm. | Grael | 0,78 € |
| TP-38.6.00 | | Bolsa solapa | 1,80 € |
| TP-40.0.00 | Ø 40 mm. | Grael | 0,82 € |
| TP-40.6.00 | | Bolsa solapa | 1,85 € |
| TP-42.0.00 | Ø 42 mm. | Grael | 0,86 € |
| TP-42.6.00 | | Bolsa solapa | 1,89 € |
| TP-44.0.00 | Ø 44 mm. | Grael | 0,94 € |
| TP-44.6.00 | | Bolsa solapa | 1,97 € |
| TP-46.0.00 | Ø 46 mm. | Grael | 1,03 € |
| TP-46.6.00 | | Bolsa solapa | 2,05 € |
| TP-47.0.00 | Ø 47 mm. | Grael | 1,03 € |
| TP-47.6.00 | | Bolsa solapa | 2,05 € |
| TP-50.0.00 | Ø 50 mm. | Grael | 1,23 € |
| TP-50.6.00 | | Bolsa solapa | 2,26 € |
| TP-55.0.00 | Ø 55 mm. | Grael | 1,27 € |
| TP-55.6.00 | | Bolsa solapa | 2,30 € |

LAVABO LUJO
· Con cadena
· Cromado



| | | | |
|-------------|----------|---------|--------|
| AF-422.0.00 | Ø 44 mm. | Grael | 4,80 € |
| AF-422.2.00 | | Blíster | 5,80 € |

LAVABO y BIDÉ LUJO
· Con cadena + rejilla
· Cromado



| | | | |
|-------------|----------|---------|--------|
| AF-421.0.00 | Ø 44 mm. | Grael | 6,85 € |
| AF-421.2.00 | | Blíster | 8,14 € |

FREGADERO
· Con cadena



| | | | |
|-------------|----------|---------|--------|
| TP-44F.0.00 | Ø 44 mm. | Grael | 1,35 € |
| TP-44F.6.00 | | Blíster | 2,38 € |

Accesorios



| | | | |
|------------|--------|-------|--------|
| CD-25.0.00 | 25 cm. | Grael | 0,62 € |
|------------|--------|-------|--------|

CADENA DE BOLAS
· Cromado

| | | | |
|------------|--------|-------|--------|
| CD-40.0.00 | 40 cm. | Grael | 0,83 € |
|------------|--------|-------|--------|

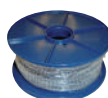

BOBINA 50m. CADENA DE BOLAS
· Cromado

| | | | |
|------------|-----------|-------|----------------------------|
| CD-01.0.00 | Ø 3,2 mm. | Grael | 1,79 € Precio por metro |
|------------|-----------|-------|----------------------------|

| | | | |
|------------|---------|-------|----------------------------|
| CD-02.0.00 | Ø 4 mm. | Grael | 2,35 € Precio por metro |
|------------|---------|-------|----------------------------|



ENGANCHE CADENA DE BOLAS
· Cromado

| | | | |
|------------|-----------|------------------|--------------------------|
| CD-03.0.00 | Ø 3,2 mm. | Bolsa 100 ud. | 0,07 € precio por ud. |
|------------|-----------|------------------|--------------------------|

| | | | |
|------------|---------|------------------|--------------------------|
| CD-04.0.00 | Ø 4 mm. | Bolsa 100 ud. | 0,07 € precio por ud. |
|------------|---------|------------------|--------------------------|



ENGANCHE UNIÓN CADENA DE BOLAS
· Cromado

| | | | |
|------------|-----------|------------------|--------------------------|
| CD-05.0.00 | Ø 3,2 mm. | Bolsa 100 ud. | 0,09 € precio por ud. |
|------------|-----------|------------------|--------------------------|

| | | | |
|------------|---------|------------------|--------------------------|
| CD-06.0.00 | Ø 4 mm. | Bolsa 100 ud. | 0,09 € precio por ud. |
|------------|---------|------------------|--------------------------|



ANILLO CADENA DE BOLAS
· Cromado

| | | | |
|------------|--------|------------------|--------------------------|
| CD-07.0.00 | 18 mm. | Bolsa 100 ud. | 0,09 € precio por ud. |
|------------|--------|------------------|--------------------------|

TRIÁNGULO CADENA DE BOLAS
· Cromado

| | | | |
|------------|---|------------------|--------------------------|
| CD-08.0.00 | - | Bolsa 100 ud. | 0,09 € precio por ud. |
|------------|---|------------------|--------------------------|

TAPONES



NOVEDAD

| | Referencia | Diámetro/Medida | Embalaje | Precio |
|--|--------------------|-----------------|------------------------|--------|
| FREGADERO · Cazoleta + Tapón rejilla | TP-REJILLA.0.00 | 70 mm. | Grael | 5,95 € |
| | TP-REJILLA.6.00 | | Bolsa solapa | 6,97 € |
| FREGADERO · Franke | TP-FRANKE.0.00 | 82 mm. | Grael | 3,57 € |
| | TP-FRANKE.6.00 | | Bolsa solapa | 4,59 € |
| FREGADERO · Teka | TP-TEKA.0.00 | 79 mm. | Grael | 4,84 € |
| | TP-TEKA.6.00 | | Bolsa solapa | 5,86 € |
| FREGADERO · Teka clic-clac · Universal | TP-TEKA-CLICK.0.00 | 80 mm. | Grael | 5,99 € |
| | TP-TEKA-CLICK.6.00 | | Bolsa solapa | 7,01 € |
| FREGADERO · Teka [Eje plástico] | TP-TEKA-GP.0.00 | 79 mm. | Grael | 2,20 € |
| | TP-TEKA-GP.6.00 | | Bolsa solapa | 3,32 € |
| FREGADERO · Teka [Eje metálico] | TP-TEKA-GM.0.00 | 82 mm. | Grael | 3,98 € |
| | TP-TEKA-GM.6.00 | | Bolsa solapa | 5,00 € |
| UNIVERSAL / MULTIUSOS | TP-MULTIUSOS.0.00 | Ø 86 mm. | Grael | 2,21 € |
| | TP-MULTIUSOS.6.00 | | Bolsa solapa | 3,24 € |
| ALFOMBRILLA DE SILICONA | TP-01S.6.00 | 14x14mm | Bolsa solapa (2 ud) | 5,10 € |

MANGUITO INODORO



· Flexible-extensible

| Referencia | Medidas (mm) | Embalaje | Precio |
|-------------|--------------|----------|---------|
| SF-400.7.00 | 245 - 450 | Bolsa | 13,85 € |
| SF-405.7.00 | 270 - 500 | | 13,60 € |

DESATASCADOR DE MUELLE

· Acero
· 5 mm. de grosor



| Referencia | Longitud | Embalaje | Precio |
|-------------|----------|--------------|---------|
| AF-170.6.00 | 1,50 m. | Bolsa Solapa | 7,18 € |
| AF-180.6.00 | 2,50 m. | Bolsa Solapa | 13,57 € |
| AF-190.6.00 | 5,00 m | Bolsa Solapa | 20,30 € |

REJILLAS



| | Referencia | Diámetro | Embalaje | Precio | |
|-----------------------|-----------------------|-------------|--------------|--------------|--------|
| LAVABO · Simple | RJ-SP.0.00 | 50 x 30 mm. | Granel | 0,44 € | |
| | RJ-SP.6.00 | | Bolsa solapa | 1,96 € | |
| | RJ-LV.0.00 | 65 x 30 mm. | Granel | 0,52 € | |
| | RJ-LV.6.00 | | Bolsa solapa | 2,04 € | |
| | LAVABO · Con pinza | RJ-GR.0.00 | 80 x 30 mm. | Granel | 1,07 € |
| | | RJ-GR.6.00 | | Bolsa solapa | 3,00 € |
| LAVABO · Con pinza | RJ-P.0.00 | 60 mm. | Granel | 0,53 € | |
| | RJ-P.6.00 | | Bolsa solapa | 2,12 € | |

TAPA ATRAPA PELOS



- Evita que el pelo vaya al desagüe.
- Fácil extracción para vertido en la papelera.

| Referencia | Embalaje | Precio |
|------------|----------|--------|
| PL-60.7.00 | Bolsa | 3,85 € |

SUMIDEROS



| | Referencia | Medidas | Salida | Embalaje | Precio |
|---------------------------------|-------------|---------|----------|----------|---------|
| SIFÓNICO VERTICAL · Plástico | VL-310.0.00 | 200x200 | 75-90 Ø | Granel | 13,86 € |
| | VL-320.0.00 | 150x150 | 50 -40 Ø | Granel | 9,38 € |
| | VL-330.0.00 | 100x100 | 40-32 Ø | Granel | 3,94 € |



| | | | | | |
|--|-------------|---------|------|--------|--------|
| SIFÓNICO VERTICAL-HORIZONTAL · Plástico | VL-340.0.00 | 100x100 | 40 Ø | Granel | 8,61 € |
|--|-------------|---------|------|--------|--------|

TORNILLOS

| | Referencia | | Medida | Embalaje | Precio | |
|--|------------------------------------|-------------|------------------|--------------|--------------|--------|
| | FIJACIÓN INODORO/BIDÉ VERTICAL | TOR-10.7.00 | Latón | Bolsa | 1,97 € | |
| | | TOR-10.6.00 | | Bolsa solapa | 3,12 € | |
| | | TOR-20.7.00 | Acero | Bolsa | 1,23 € | |
| | | TOR-20.6.00 | | Bolsa solapa | 2,38 € | |
| | FIJACIÓN INODORO/BIDÉ LATERAL | TOR-30.7.00 | M6x100 mm. | Bolsa | 2,12 € | |
| | | TOR-30.6.00 | | Bolsa solapa | 3,20 € | |
| | FIJACIÓN LATERAL WC ABS | TOR-35.7.00 | Ø20 63x60 mm. | Bolsa | 2,79 € | |
| | | TOR-35.6.00 | | Bolsa solapa | 3,94 € | |
| | FIJACIÓN CISTERNA | TOR-40.7.00 | M6x100 mm. | Bolsa | 4,95 € | |
| | | TOR-40.6.00 | | Bolsa solapa | 3,69 € | |
| | FIJACIÓN CISTERNA + JUNTA DESCARGA | JG-AQ.7.00 | M6x100 mm. | Bolsa | 4,30 € | |
| | FIJACIÓN LAVAMANOS | TOR-50.7.00 | M8x100 | Bolsa | 1,31 € | |
| | | TOR-50.6.00 | | Bolsa solapa | 2,46 € | |
| | | TOR-60.7.00 | M10x100 | Bolsa | 2,09 € | |
| | | TOR-60.6.00 | | Bolsa solapa | 3,24 € | |
| | FIJACIÓN PARA MONOMANDO | AF-400.6.00 | 1 tornillo | Bolsa solapa | 2,58 € | |
| | ALCAYATA PARA TERMO | TOR-70.7.00 | 1 tornillo | Ø14 | Bolsa | 1,44 € |
| | | TOR-70.6.00 | 1 tornillo | | Bolsa solapa | 2,58 € |

TAPONES ORIFICIO CISTERNA

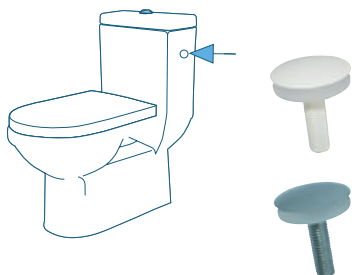

| | Referencia | Embalaje | Precio |
|---------|-------------|---------------------|--------|
| BLANCO | AF-410.6.00 | Bolsa solapa (2 ud) | 2,13 € |
| | AF-410.7.00 | Bolsa | 0,66 € |
| CROMADO | AF-420.6.00 | Bolsa solapa (2 ud) | 2,71 € |
| | AF-420.7.00 | Bolsa | 0,99 € |

EMBELLECEDOR PARA REBOSADERO

· Ø interior 22mm.

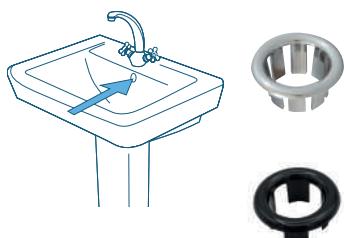

| | Referencia | Embalaje | Precio |
|---------|---------------|--------------|--------|
| CROMADO | AF-423.6.00 | Bolsa solapa | 2,71€ |
| NEGRO | AF-423NG.6.00 | Bolsa solapa | 2,56 € |

TIRADOR CISTERNA-BAJA

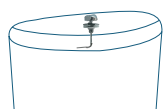

| | Referencia | Embalaje | Precio |
|-------|-------------|--------------|--------|
| CURVO | AF-270.6.00 | Bolsa solapa | 4,10 € |
| | AF-280.6.00 | Bolsa solapa | 4,10 € |

TIRADOR CISTERNA-ALTA

· Cadena de acero inoxidable

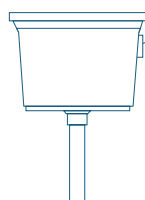

| | Referencia | Embalaje | Precio |
|--------------------------|-------------|--------------|--------|
| POMO | AF-240.6.00 | Bolsa solapa | 3,59 € |
| METACRILATO TRANSPARENTE | AF-250.6.00 | Bolsa solapa | 5,28 € |

DESCARGAS CISTERNA

· Fácil instalación



TIPO FOMINAYA
· Tanque bajo

| Referencia | Embalaje | Precio |
|-------------|--------------|--------|
| AQ-110.6.00 | Bolsa solapa | 9,10 € |
| AQ-110.7.00 | Bolsa | 8,08 € |

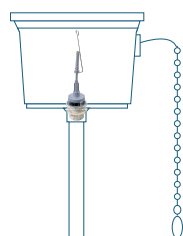

TIPO FOMINIYA
· Tanque alto

| | | |
|-------------|--------------|--------|
| AQ-111.6.00 | Bolsa solapa | 6,72 € |
| AQ-111.7.00 | Bolsa | 5,21 € |

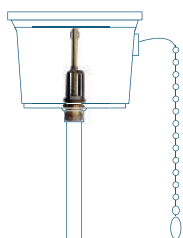

MUELLE

| | | |
|-------------|--------|---------|
| AF-120.0.00 | Granel | 33,95 € |
|-------------|--------|---------|

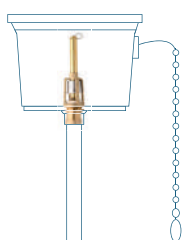









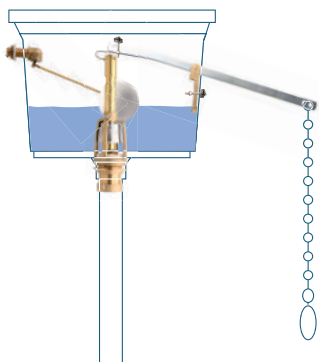

PLOMO

| | | | |
|-------------|-----------|--------|---------|
| AF-130.0.00 | Estándar | Granel | 31,90 € |
| AF-140.0.00 | Reforzado | Granel | 46,49 € |







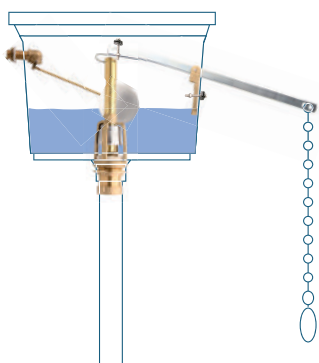

CONJUNTOS DESCARGA CISTERNA-ALTA

· Adaptable a todas las cisternas
· Fácil instalación



| | Referencia | Embalaje | Precio |
|---|---|-------------|----------------|
| ESTÁNDAR | AF-100.5.00 | Caja | 51,65 € |
|  Componentes | | | |
|  | Junta goma blanca plana | JG-050.0.00 | |
|  | Junta semicónica | JG-130.0.00 | |
|  | Descarga cisterna plomo [SIMPLE] | AF-130.0.00 | |
|  | Palanca cisterna con balancín reforzado | AF-160.0.00 | |
|  | Juego 2 tornillos | AF-220.0.00 | |
|  | Tirador cisterna pomo | AF-240.7.00 | |
|  | Flotador cisterna olleta | FG-180.0.00 | |
|  | Boya porexpán autorroscable | BP-009.0.00 | |



| | Referencia | Embalaje | Precio |
|---|---|-------------|----------------|
| SÚPER | AF-110.5.00 | Caja | 66,01 € |
|  Componentes | | | |
|  | Junta goma blanca plana | JG-050.0.00 | |
|  | Junta semicónica | JG-130.0.00 | |
|  | Descarga cisterna plomo [REFORZADA] | AF-140.0.00 | |
|  | Palanca cisterna con balancín reforzado | AF-160.0.00 | |
|  | Juego 2 tornillos | AF-220.0.00 | |
|  | Tirador cisterna pomo | AF-240.7.00 | |
|  | Flotador cisterna olleta | FG-180.0.00 | |
|  | Boya porexpán autorroscable | BP-009.0.00 | |

MANGUERAS

· Fácil instalación



| | Referencia | Medidas | Salida | Embalaje | Precio |
|--|-------------|----------------|---------------|--------------|---------|
| EVACUACIÓN · Plástico corrugado · Adaptable a todos los modelos | AF-010.0.00 | 1,50 m. | Boquilla goma | Grael | 2,05 € |
| | AF-010.6.00 | | | Bolsa solapa | 3,08 € |
| | AF-011.0.00 | 2,00 m. | | Grael | 2,18 € |
| | AF-011.6.00 | | | Bolsa solapa | 3,61 € |
| EVACUACIÓN EXTENSIBLE · Plástico corrugado · Adaptable a todos los modelos | AF-013.0.00 | 0,90 m. - 3 m. | Boquilla goma | Grael | 3,28 € |
| | AF-013.6.00 | | | Bolsa solapa | 4,51 € |
| | AF-016.0.00 | 1,20 m. - 4 m. | | Grael | 5,29 € |
| | AF-016.6.00 | | | Bolsa solapa | 6,52 € |
| ALIMENTACIÓN · Tubo de goma · Presión de trabajo 12 bars · Presión de rotura 30 bars | AF-050.0.00 | 1,50 m. | Tuerca latón | Grael | 6,23 € |
| | AF-050.6.00 | | | Bolsa solapa | 8,20 € |
| | AF-060.0.00 | 2,00 m. | | Grael | 6,85 € |
| | AF-060.6.00 | | | Bolsa solapa | 8,16 € |
| | AF-062.0.00 | 2,50 m. | | Grael | 8,53 € |
| | AF-062.6.00 | | | Bolsa solapa | 10,04 € |
| | AF-064.0.00 | 3,00 m. | | Grael | 8,77 € |
| | AF-064.6.00 | | | Bolsa solapa | 10,82 € |
| ALIMENTACIÓN NYLON · Tubo de goma · Presión de trabajo 12 bars · Presión de rotura 30 bars | AF-051.0.00 | 1,50 m. | Tuerca nylon | Grael | 3,99 € |
| | AF-051.6.00 | | | Bolsa solapa | 5,00 € |
| | AF-061.0.00 | 2,00 m. | | Grael | 4,66 € |
| | AF-061.6.00 | | | Bolsa solapa | 5,70 € |
| | AF-063.0.00 | 2,50 m. | | Grael | 5,21 € |
| | AF-063.6.00 | | | Bolsa solapa | 6,44 € |
| ALIMENTACIÓN CON TRENZADO INOX · Tubo de goma · Presión de trabajo 12 bars · Presión de rotura 30 bars | AF-055.0.00 | 1,50 m. | Tuerca latón | Grael | 10,66 € |
| | AF-055.6.00 | | | Bolsa solapa | 11,97 € |
| | AF-065.0.00 | 2,00 m. | | Grael | 12,01 € |
| | AF-065.6.00 | | | Bolsa solapa | 13,28 € |

Fabricación en cualquier longitud

ACCESORIOS



| | | | | | |
|--|-------------|-------------|----------------|--------------|--------|
| BOQUILLA EMPALME TUBO EVACUACIÓN · PVC. | AF-014.0.00 | Ø 23 - Ø 21 | Grael | 0,41 € | |
| | AF-014.6.00 | | Bolsa solapa | 1,44 € | |
| EMPALME DOBLE en "Y" · Adecuado para lavadora y lavavajillas | AF-015.0.00 | H3/4" | M3/4" M3/4" | Grael | 2,27 € |
| | AF-015.6.00 | | | Bolsa solapa | 3,68 € |

TUBO VENTILACIÓN Y EXTRACCIÓN



- Blanco
- Flexible

| Referencia | Longitud | Medida | Embalaje | Precio |
|-------------|----------|-----------|----------|---------|
| AF-482.0.00 | 3 m. | Ø 102 mm. | Granel | 19,77 € |
| AF-481.0.00 | | Ø 125 mm. | Granel | 23,86 € |

REJILLA VENTILACIÓN PLANA



- Blanco
- Empotrable

| Referencia | Medida | Embalaje | Precio |
|-------------|-----------|----------|--------|
| AF-472.0.00 | 15x15 cm. | Granel | 3,08 € |
| AF-473.0.00 | 20x20 cm. | Granel | 3,94 € |

REJILLA VENTILACIÓN RECTANGULAR

- Rectangular de plástico
- 22 x 9,5 cm



| | Referencia | Embalaje | Precio |
|------------------------|-------------|----------|--------|
| CON MARCO | AF-560.0.00 | Granel | 3,36 € |
| CON MARCO + MOSQUITERA | AF-570.0.00 | Granel | 4,51 € |

CINTA PERFORADA

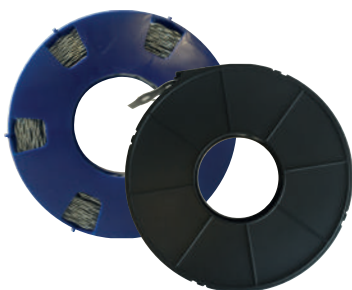

| Referencia | Longitud | Medida | Embalaje | Precio |
|-------------|----------|-------------|----------|--------|
| AF-530.0.00 | 10 m. | 17 x 08 mm. | Granel | 9,49 € |

LLAVE PURGADOR RADIADOR



- Saca el aire acumulado en el radiador
- Desobstrucción paso del calor

| Referencia | Embalaje | Precio |
|----------------|--------------|--------|
| LLAVE-010.7.00 | Granel | 0,42 € |
| LLAVE-010.6.00 | Bolsa solapa | 1,16 € |

PLAFÓN RADIADOR



- Universal

| | Referencia | Embalaje | Precio |
|--------|-----------------|----------|--------|
| Simple | PLAFON-010.0.00 | Granel | 0,40 € |
| Doble | PLAFON-020.0.00 | Granel | 1,03 € |

SOPORTES RADIADOR



- PLÁSTICO**
- Atornilla en U
 - Universal

| Referencia | Embalaje | Precio |
|------------------|----------|--------|
| SOPORTE-020.0.00 | Granel | 1,31 € |



- METÁLICO ALTO REGULABLE**
- Incorpora tornillo regulador de altura
 - Atornilla en uña

| Referencia | Embalaje | Precio |
|------------------|----------|--------|
| SOPORTE-030.7.00 | Granel | 1,73 € |

ARMARIO CUBRE CALDERA



- Con salida superior
- Fabricado en chapa galvanizada
- Ideal para organizar el interior de sótanos o trasteros

| Referencia | Altura | Anchura | Profundidad | Embalaje | Precio |
|--------------|--------|---------|-------------|----------|----------|
| ARM-011.5.00 | 80 cm | 48 cm | 30 cm | Caja | 174,00 € |
| ARM-013.5.00 | 87 cm | 50 cm | 35 cm | Caja | 192,00 € |

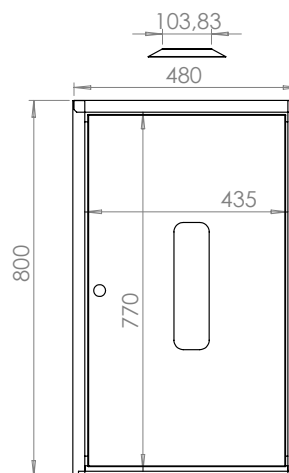

TEJADILLO PARA ARMARIO CUBRE CALDERA



- Acero lacado blanco

| Referencia | Medida | Embalaje | Precio |
|--------------|------------|----------|---------|
| TEJ-010.5.00 | 60 x 50 cm | Caja | 66,45 € |

JUNTA GOMA BLANCA PLANA



| Referencia | Medida | Embalaje | Precio |
|-------------|--------|---------------------|---------|
| JG-020.7.00 | | Bolsa (50 ud) | 8,20 € |
| JG-020.6.00 | 1/2" | Bolsa solapa (6 ud) | 1,96 € |
| JG-021.6.00 | | Bolsa solapa (2 ud) | 1,50 € |
| JG-030.7.00 | | Bolsa (50 ud) | 10,80 € |
| JG-030.6.00 | 3/4" | Bolsa solapa (6 ud) | 2,28 € |
| JG-031.6.00 | | Bolsa solapa (2 ud) | 1,62 € |

| Referencia | Medida | Embalaje | Precio |
|-------------|--------|---------------------|---------|
| JG-040.7.00 | | Bolsa (50 ud) | 13,56 € |
| JG-041.6.00 | 1" | Bolsa solapa (2 ud) | 1,72 € |
| JG-050.7.00 | | Bolsa (10 ud) | 2,92 € |
| JG-051.6.00 | 1.1/4" | Bolsa solapa (2 ud) | 1,70€ |
| JG-060.7.00 | 1.1/2" | Bolsa (10 ud) | 2,52 € |
| JG-080.7.00 | 2" | Bolsa (10 ud) | 2,24 € |



JUNTA GOMA CÓNICA

| Referencia | Medida | Embalaje | Precio |
|-------------|--------|----------|--------|
| JG-100.6.00 | 1/2" | | 3,72 € |
| JG-110.6.00 | 3/4" | | 4,00 € |
| JG-120.6.00 | 1" | | 3,84 € |



JUNTA GOMA SEMICÓNICA

| Referencia | Medida | Embalaje | Precio |
|-------------|--------|--------------|--------|
| JG-135.7.00 | 1/2" | Bolsa 10 ud. | 7,45 € |
| JG-145.7.00 | 3/4" | Bolsa 10 ud. | 7,56 € |
| JG-155.7.00 | 1" | Bolsa 10 ud. | 6,72 € |



JUNTA GOMA CONEXIÓN

| Referencia | Medida | Embalaje | Precio |
|-------------|--------|---------------------|--------|
| SF-525.6.00 | Ø80 mm | Bolsa solapa (4 ud) | 2,80 € |



JUNTA GOMA CONEXIÓN

| Referencia | Medida | Embalaje | Precio |
|-------------|--------|----------------------|--------|
| JG-160.7.00 | | Bolsa 50 ud. | 1,36 € |
| JG-160.6.00 | 3/8" | Bolsa solapa (20 ud) | 1,08 € |
| JG-170.7.00 | | Bolsa 50 ud. | 1,56 € |
| JG-170.6.00 | 1/2" | Bolsa solapa (20 ud) | 1,16 € |
| JG-180.7.00 | | Bolsa 50 ud. | 2,28 € |
| JG-180.6.00 | 3/4" | Bolsa solapa (20 ud) | 1,48 € |



JUNTA GOMA CONEXIÓN

| Referencia | Medida | Embalaje | Precio |
|-------------|---------|---------------------|--------|
| SF-550.6.00 | Ø70 mm | Bolsa solapa (4 ud) | 2,80 € |
| SF-555.6.00 | Ø115 mm | Bolsa solapa (2 ud) | 2,80 € |



JUNTA GOMA CONEXIÓN

| Referencia | Medida | Embalaje | Precio |
|-------------|--------|---------------------|--------|
| SF-560.6.00 | 1"1/2 | Bolsa solapa (4 ud) | 2,80 € |
| SF-565.6.00 | 1"1/4 | Bolsa solapa (4 ud) | 2,80 € |

JUNTA RACOR 2 PIEZAS



| Referencia | Medida | Embalaje | Precio |
|-------------|--------|----------------------|--------|
| JG-230.7.00 | 1/2" | Bolsa 50 ud. | 2,64 € |
| JG-230.6.00 | | Bolsa solapa (20 ud) | 1,56 € |
| JG-240.7.00 | 3/4" | Bolsa 50 ud. | 2,84 € |
| JG-240.6.00 | | Bolsa solapa (20 ud) | 1,60 € |

| Referencia | Medida | Embalaje | Precio |
|-------------|--------|----------------------|--------|
| JG-250.7.00 | 1" | Bolsa 50 ud. | 3,16 € |
| JG-250.6.00 | | Bolsa solapa (20 ud) | 2,56 € |
| JG-260.7.00 | 1.1/4" | Bolsa 50 ud. | 4,20 € |
| JG-260.6.00 | | Bolsa solapa (20 ud) | 2,92 € |
| JG-270.7.00 | 1.1/2" | Bolsa 50 ud. | 5,76 € |
| JG-270.6.00 | | Bolsa solapa (20 ud) | 3,52 € |

GOMA DESCARGA



Tipo Roca

| Referencia | Medida | Embalaje | Precio |
|-------------|---------|---------------------|--------|
| JG-410.7.00 | 70*23*3 | Bolsa 10 ud. | 6,24 € |
| JG-410.6.00 | | Bolsa solapa (4 ud) | 3,56 € |
| JG-415.7.00 | 68*33*3 | Bolsa 10 ud. | 5,60 € |
| JG-416.7.00 | 66*17*2 | Bolsa 10 ud. | 6,56 € |

Tipo Fominaya Tanque bajo

| Referencia | Medida | Embalaje | Precio |
|-------------|---------|--------------|---------|
| JG-420.7.00 | 68*17*3 | Bolsa 10 ud. | 12,44 € |

JUNTA TÓRICA



| Referencia | Medida | Embalaje | Precio |
|------------|---------------------------|----------------------|--------|
| TR-01.6.00 | AN-1 NBR 70 (2,90 X 1,78) | Bolsa solapa (10 ud) | 0,88 € |
| TR-02.6.00 | AN-2 NBR 70 (3,68 X 1,78) | Bolsa solapa (10 ud) | 0,92 € |
| TR-03.6.00 | AN-3 NBR 70 (4,47 X 1,78) | Bolsa solapa (10 ud) | 0,92 € |
| TR-04.6.00 | AN-4 NBR 70 (5,28 X 1,78) | Bolsa solapa (10 ud) | 0,88 € |
| TR-05.6.00 | AN-5 NBR 70 (6,07 X 1,78) | Bolsa solapa (10 ud) | 0,88 € |
| TR-06.6.00 | AN-6 NBR 70 (7,65 X 1,78) | Bolsa solapa (10 ud) | 0,88 € |
| TR-07.6.00 | AN-7 NBR 70 (9,25 X 1,78) | Bolsa solapa (10 ud) | 0,92 € |

| Referencia | Medida | Embalaje | Precio |
|-------------|-----------------------------|----------------------|--------|
| TR-08.6.00 | AN-8 NBR 70 (9,19 X 2,62) | Bolsa solapa (10 ud) | 1,08 € |
| TR-09.6.00 | AN-9 NBR 70 (10,77 X 2,62) | Bolsa solapa (10 ud) | 1,04 € |
| TR-010.6.00 | AN-10 NBR 70 (12,37 X 2,62) | Bolsa solapa (10 ud) | 1,04 € |
| TR-011.6.00 | AN-11 NBR 70 (13,94 X 2,62) | Bolsa solapa (10 ud) | 1,08 € |
| TR-012.6.00 | AN-12 NBR 70 (15,54 X 2,62) | Bolsa solapa (10 ud) | 1,08 € |
| TR-013.6.00 | AN-13 NBR 70 (17,12 X 2,62) | Bolsa solapa (10 ud) | 1,16 € |
| TR-014.6.00 | AN-14 NBR 70 (18,72 X 2,62) | Bolsa solapa (10 ud) | 1,16 € |

JUNTA CONICA DE SIFÓN/VÁLVULA



| Referencia | Diámetro | Medida | Embalaje | Precio |
|-------------|----------|--------|---------------------|--------|
| SF-410.6.00 | 40 | 1.1/2" | Bolsa solapa (4 ud) | 2,64 € |
| SF-420.6.00 | 32 | 1.1/4" | Bolsa solapa (4 ud) | 2,64 € |
| SF-430.6.00 | 40 y 32 | | Bolsa solapa (4 ud) | 2,37 € |



KIT JUNTAS SOLETA GOMA GRIFO

Componentes

-  4 JUNTAS GOMA GRIFO PERFORADA 13 (16*4*4)
-  4 JUNTAS GOMA GRIFO PERFORADA 16 (18*4*4)
-  4 JUNTAS GOMA GRIFO PERFORADA 20 (20*4*4)

| Referencia | Embalaje | Precio |
|------------|----------------------|--------|
| JG-SL.6.00 | Bolsa solapa (12 ud) | 2,06 € |



KIT JUNTAS TÓRICA

Componentes

| | |
|------------------------------------|--------------------------------------|
| 5 Juntas AN-1 NBR 70 (2,90 X 1,78) | 5 Juntas AN-8 NBR 70 (9,19 X 2,62) |
| 5 Juntas AN-2 NBR 70 (3,68 X 1,78) | 5 Juntas AN-9 NBR 70 (10,77 X 2,62) |
| 5 Juntas AN-3 NBR 70 (4,47 X 1,78) | 5 Juntas AN-10 NBR 70 (12,37 X 2,62) |
| 5 Juntas AN-4 NBR 70 (5,28 X 1,78) | 5 Juntas AN-11 NBR 70 (13,94 X 2,62) |
| 5 Juntas AN-5 NBR 70 (6,07 X 1,78) | 5 Juntas AN-12 NBR 70 (15,54 X 2,62) |
| 5 Juntas AN-6 NBR 70 (7,56 X 1,78) | 5 Juntas AN-13 NBR 70 (17,12 X 2,62) |
| 5 Juntas AN-7 NBR 70 (9,25 X 1,78) | 5 Juntas AN-14 NBR 70 (18,72 X 2,62) |

| Referencia | Embalaje | Precio |
|------------|----------------------|--------|
| JG-TR.6.00 | Bolsa solapa (70 ud) | 3,26 € |



KIT JUNTAS CONEXIÓN

Componentes

-  5 JUNTAS GOMA 3/8"
-  5 JUNTAS GOMA 1/2"
-  5 JUNTAS GOMA 3/4"

| Referencia | Embalaje | Precio |
|------------|----------------------|--------|
| JG-CX.6.00 | Bolsa solapa (30 ud) | 2,09 € |



KIT JUNTAS GOMA BLANCA PLANA

Componentes

- 5 JUNTAS GOMA BLANCA 3/8"
- 5 JUNTAS GOMA BLANCA 1/2"
- 5 JUNTAS GOMA BLANCA 3/4"
- 5 JUNTAS GOMA BLANCA 1"

| Referencia | Embalaje | Precio |
|------------|----------------------|--------|
| JG-PL.6.00 | Bolsa solapa (20 ud) | 4,55 € |



KIT JUNTAS RACOR 2 PIEZAS

Componentes

- 10 JUNTAS RACOR 2 PIEZAS 3/8"
- 10 JUNTAS RACOR 2 PIEZAS 1/2"
- 10 JUNTAS RACOR 2 PIEZAS 3/4"

| Referencia | Embalaje | Precio |
|------------|----------------|--------|
| JG-CG.6.00 | Blíster 30 ud. | 2,30 € |



MALETA JUNTAS CONEXIÓN Y RACOR 2 PIEZAS

Componentes

| | | | | | |
|-----|-----------------------------|-----|------------------------------|----|-------------------------------|
| 200 | Juntas goma conexión 3/8 | 200 | Juntas racor 2 piezas 3/8" | 50 | Juntas goma blanca plana 3/8" |
| 200 | Juntas goma conexión 1/2 | 200 | Juntas racor 2 piezas 1/2" | 50 | Juntas goma blanca plana 1/2" |
| 100 | Juntas goma conexión 3/4 | 100 | Juntas racor 2 piezas 3/4" | | |
| 50 | Juntas goma conexión 1" | 50 | Juntas racor 2 piezas 1" | | |
| 25 | Juntas goma conexión 1.1/4" | 25 | Juntas racor 2 piezas 1.1/4" | | |
| 25 | Juntas goma conexión 1.1/2" | 25 | Juntas racor 2 piezas 1.1/4" | | |

| Referencia | Embalaje | P.V.P. |
|------------|------------------|--------|
| MT-02.0.00 | Estuche 1350 ud. | 118 € |

+ Disponible maleta vacía (MT-01.0.00)



MALETA JUNTAS TÓRICAS Y SOLETAS

Componentes

| | | | | | |
|----|-----------------------------|----|-------------------------|----|---------------------------|
| 25 | Soleta goma grifo 11 (14x4) | 50 | Tórica AN-1 (2,90x1,78) | 50 | Tórica AN-8 (9,19x2,62) |
| 25 | Soleta goma grifo 13 (16x4) | 50 | Tórica AN-2 (3,68x1,78) | 50 | Tórica AN-9 (10,77x2,62) |
| 25 | Soleta goma grifo 16 (18x4) | 50 | Tórica AN-3 (4,47x1,78) | 50 | Tórica AN-10 (12,37x2,62) |
| 25 | Soleta goma grifo 11 CIEGA | 50 | Tórica AN-4 (5,28x1,78) | 50 | Tórica AN-11 (13,94x2,62) |
| 25 | Soleta goma grifo 13 CIEGA | 50 | Tórica AN-5 (6,07x1,78) | 50 | Tórica AN-12 (15,52x2,62) |
| 25 | Soleta goma grifo 16 CIEGA | 50 | Tórica AN-6 (7,56x1,78) | 50 | Tórica AN-13 (17,12x2,62) |
| 25 | Soleta goma grifo 20 CIEGA | 50 | Tórica AN-7 (9,25x1,78) | 50 | Tórica AN-14 (18,72x2,62) |

| Referencia | Embalaje | Precio |
|------------|-----------------|---------|
| MT-03.0.00 | Estuche 875 ud. | 93,40 € |

+ Disponible maleta vacía (MT-01.0.00)

NOVEDAD CINTA PTFE

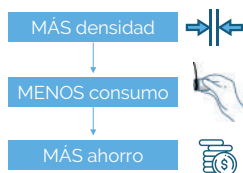

- Alta densidad
- 0,35 g/cm³
- Para sellar uniones roscadas.



| | Referencia | Largo | Embalaje | Precio |
|--|------------|-------|----------|--------|
| Ancho: 12 mm. Grosor: 0,075 mm. Largo: 12 m. | TF-12.0.00 | 12 m. | Grael | 0,44 € |



| | | | | |
|--|------------|-------|-------|--------|
| APTO PARA GAS Ancho: 12 mm. Grosor: 0,1 mm. Largo: 12 m. | TF-13.0.00 | 12 m. | Grael | 0,52 € |
|--|------------|-------|-------|--------|



| | | | | |
|--|------------|-------|-------|--------|
| Ancho: 19 mm. Grosor: 0,1 mm. Largo: 50 m. | TF-19.0.00 | 50 m. | Grael | 2,19 € |
|--|------------|-------|-------|--------|

NOVEDAD HILO PTFE



| | Referencia | Largo | Embalaje | Precio |
|--------------|-------------|-------|----------|--------|
| BOBINA 50 m. | TF-H50.0.00 | 50 m. | Grael | 9,13 € |

| | | | | |
|---------------|--------------|--------|-------|---------|
| BOBINA 150 m. | TF-H150.0.00 | 150 m. | Grael | 19,78 € |
|---------------|--------------|--------|-------|---------|

NOVEDAD ADHESIVO PVC



ADH-020

ADH-040



ADH-050

· Adhesivo especial para la unión de tuberías y accesorios PVC. Recomendado para sistemas con presión y en instalaciones que requieren un Freguado rápido. Indicado en instalaciones industriales con elevadas exigencias.

| | Referencia | Embalaje | Precio |
|----------------------------|--------------|----------------------|---------|
| ADHESIVO PARA PVC RIGIDO | ADH-040.0.00 | TUBO 125 ML. | 2,69 € |
| | ADH-040.5.00 | TUBO 125 ML. EN CAJA | 3,12 € |
| | ADH-030.0.00 | BOTE 250 ML. | 8,06 € |
| | ADH-020.0.00 | BOTE 500 ML. | 10,82 € |
| | ADH-010.0.00 | BOTE 1000 ML. | 16,79 € |
| ADHESIVO PARA PVC FLEXIBLE | ADH-050.5.00 | BOTE 250 ML. | 10,90 € |

NOVEDAD LIMPIADOR PVC



· Especialmente diseñado para la limpieza, desengrasado y preparación de las superficies a unir.

| | Referencia | Embalaje | Precio |
|--------------------|---------------|--------------|--------|
| LIMPIADOR PARA PVC | LIMP-010.0.00 | BOTE 500 ML. | 6,28 € |

NOVEDAD MASILLA EPOXI



· Masilla epoxi rápida de dos componentes concéntricos para reparación de emergencia o definitivas de tuberías metálicas o de PVC, depósitos de agua, fugas en conexiones, válvulas y piezas de unión.

| | Referencia | Embalaje | Precio |
|---------------|--------------|---------------|---------|
| MASILLA EPOXI | EPO-010.0.00 | BARRA 114 GR. | 10,27 € |

MASILLA CLÁSICA FONTANERO



- Fácil de aplicar sin herramientas.
- Moldeable.
- Puede pintarse.
- Adherible a superficies húmedas, exteriores e interiores, especial para juntas, ventanas, sanitarios, PVC, metal, plomo, uralita, etc.

| Referencia | Embalaje | Precio |
|------------|-----------------|--------|
| MS-01.0.00 | AL VACIO 800 GR | 4,44 € |

RACOR REPARACIÓN HEMBRA



| Referencia | Medida | Embalaje | Precio |
|--------------|--------|--------------|---------|
| RA-1030.0.00 | H1/2" | Granel | 22,44 € |
| RA-1030.6.00 | | Bolsa solapa | 22,44 € |
| RA-1031.0.00 | H3/4" | Granel | 22,44 € |
| RA-1031.6.00 | | Bolsa solapa | 22,04 € |
| RA-1032.0.00 | H1" | Granel | 23,08 € |
| RA-1032.6.00 | | Bolsa solapa | 24,68 € |

ABRAZADERA TIPO DC



· Fundición maleable. Para tubo de acero

| Referencia | Medida | Embalaje | Precio |
|--------------|--------|--------------|---------|
| RA-1100.0.00 | 1/2" | Granel | 11,83 € |
| RA-1100.6.00 | | Bolsa solapa | 13,20 € |
| RA-1101.0.00 | 3/4" | Granel | 12,04 € |
| RA-1101.6.00 | | Bolsa solapa | 13,68 € |
| RA-1102.0.00 | 1" | Granel | 16,12 € |
| RA-1102.6.00 | | Bolsa solapa | 17,72 € |

RACOR REPARACIÓN MACHO



| Referencia | Medida | Embalaje | Precio |
|--------------|--------|--------------|---------|
| RA-1009.6.00 | M 3/8" | Bolsa solapa | 19,64 € |
| RA-1010.0.00 | M 1/2" | Granel | 18,04 € |
| RA-1010.6.00 | | Bolsa solapa | 19,64 € |
| RA-1012.0.00 | M 3/4" | Granel | 19,96 € |
| RA-1012.6.00 | | Bolsa solapa | 21,56 € |
| RA-1013.0.00 | M 1" | Granel | 22,76 € |
| RA-1013.6.00 | | Bolsa solapa | 24,36 € |

MANGUITO ANTIELECTROLISIS

· Evita la electrólisis producida por la unión de cobre y el hierro galvanizado

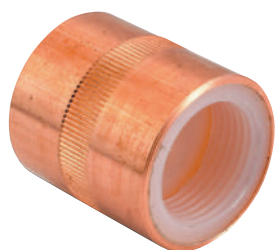

| Referencia | Medida | Embalaje | Precio |
|-------------|---------|--------------|--------|
| RA-695.0.00 | 1/2" HH | Granel | 3,84 € |
| RA-695.6.00 | | Bolsa solapa | 5,04 € |
| RA-696.0.00 | 1/2" MH | Granel | 4,16 € |
| RA-696.6.00 | | Bolsa solapa | 5,36 € |

| Referencia | Medida | Embalaje | Precio |
|-------------|---------|--------------|--------|
| RA-705.0.00 | 3/4" HH | Granel | 4,56 € |
| RA-705.6.00 | | Bolsa solapa | 5,76 € |
| RA-706.0.00 | 3/4" MH | Granel | 5,64 € |
| RA-706.6.00 | | Bolsa solapa | 6,84 € |

ABRAZADERA TIPO RD

· Fisuras y poros. Para tubo de cobre



| Referencia | Medida | Embalaje | Precio |
|--------------|----------|--------------|---------|
| RA-1015.0.00 | Ø 15 mm. | Granel | 16,96 € |
| RA-1015.6.00 | | Bolsa solapa | 18,16 € |
| RA-1018.0.00 | Ø 18 mm. | Granel | 16,48 € |
| RA-1018.6.00 | | Bolsa solapa | 18,16 € |
| RA-1022.0.00 | Ø 22 mm. | Granel | 22,08 € |
| RA-1022.6.00 | | Bolsa solapa | 23,28 € |

RACOR DEPOSITO URALITA CON TUERCA CORREDERA

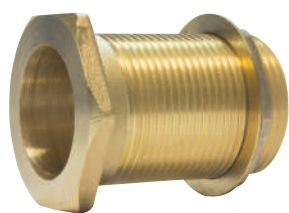

| Referencia | Medida | Embalaje | Precio |
|-------------|--------|--------------|--------|
| RA-910.0.00 | 1/2" | Granel | 5,11 € |
| RA-910.6.00 | | Bolsa solapa | 6,22 € |
| RA-920.0.00 | 3/4" | Granel | 7,18 € |
| RA-920.6.00 | | Bolsa solapa | 7,87 € |

| Referencia | Medida | Embalaje | Precio |
|-------------|--------|--------------|---------|
| RA-930.0.00 | 1" | Granel | 9,45 € |
| RA-930.6.00 | | Bolsa solapa | 10,32 € |
| RA-940.0.00 | 1.1/4" | Granel | 12,34 € |
| RA-940.6.00 | | Bolsa solapa | 13,47 € |
| RA-950.0.00 | 1.1/2" | Granel | 19,91 € |

RACOR MARSELLA



▼ LATÓN:

| Referencia | Medida | Embalaje | Precio |
|--------------|--------------------|----------------------|--------|
| RA-330.0.00 | M3/8" - H3/8" | Granel | 0,98 € |
| RA-330.6.00 | | Bolsa solapa (2 und) | 4,18 € |
| RA-340.0.00 | M3/8" - H1/2" | Granel | 1,46 € |
| RA-340.6.00 | | Bolsa solapa (2 und) | 4,13 € |
| RA-350.0.00 | M1/2" - H3/8" | Granel | 2,65 € |
| RA-350.6.00 | | Bolsa solapa (2 und) | 6,50 € |
| RA-360.0.00 | M1/2" - H1/2" | Granel | 1,80 € |
| RA-360.6.00 | | Bolsa solapa (2 und) | 4,81 € |
| RA-3602.0.00 | M1/2 - H1/2 x 2 CM | Granel | 2,39 € |
| RA-3602.6.00 | | Bolsa solapa (2 und) | 5,98 € |
| RA-380.0.00 | M1/2" - H3/4" | Granel | 2,58 € |
| RA-380.6.00 | | Bolsa solapa | 3,78 € |
| RA-390.0.00 | M1/2" - H1" | Granel | 5,48 € |
| RA-390.6.00 | | Bolsa solapa | 6,45 € |
| RA-400.0.00 | M3/4" - H1/2" | Granel | 3,75 € |
| RA-400.6.00 | | Bolsa solapa | 4,95 € |
| RA-410.0.00 | M3/4" - H3/4" | Granel | 2,31 € |
| RA-410.6.00 | | Bolsa solapa | 3,51 € |
| RA-420.0.00 | M3/4" - H1" | Granel | 4,67 € |

▼ CROMADO:

| Referencia | Medida | Embalaje | Precio |
|-------------|---------------|----------------------|--------|
| RA-331.0.00 | M3/8" - H3/8" | Granel | 1,97 € |
| RA-331.6.00 | | Bolsa solapa (2 und) | 5,14 € |
| RA-341.0.00 | M3/8" - H1/2" | Granel | 2,81 € |
| RA-341.6.00 | | Bolsa solapa (2 und) | 6,83 € |
| RA-351.0.00 | M1/2" - H3/8" | Granel | 2,31 € |
| RA-351.6.00 | | Bolsa solapa (2 und) | 5,82 € |
| RA-361.0.00 | M1/2" - H1/2" | Granel | 2,93 € |
| RA-361.6.00 | | Bolsa solapa (2 und) | 7,06 € |
| RA-381.0.00 | M1/2" - H3/4" | Granel | 2,98 € |
| RA-381.6.00 | | Bolsa solapa | 3,58 € |
| RA-391.0.00 | M1/2" - H1" | Granel | 5,12 € |
| RA-391.6.00 | | Bolsa solapa | 6,28 € |
| RA-401.0.00 | M3/4" - H1/2" | Granel | 3,87 € |
| RA-401.6.00 | | Bolsa solapa | 5,07 € |
| RA-411.0.00 | M3/4" - H3/4" | Granel | 3,73 € |
| RA-411.6.00 | | Bolsa solapa | 4,93 € |
| RA-421.0.00 | M3/4" - H1" | Granel | 4,48 € |

REDUCCIÓN HEXAGONAL



▼ LATÓN:

| Referencia | Medida | Embalaje | Precio |
|-------------|-------------------|----------------------|---------|
| RA-460.0.00 | H3/8" - M1/2" | Granel | 0,93 € |
| RA-460.6.00 | | Bolsa solapa (2 und) | 3,06 € |
| RA-470.0.00 | H1/2" - M3/4" | Granel | 1,40 € |
| RA-470.6.00 | | Bolsa solapa (2 und) | 4,00 € |
| RA-500.0.00 | H1/2" - M1" | Granel | 1,29 € |
| RA-500.6.00 | | Bolsa solapa | 2,44 € |
| RA-480.0.00 | H3/4" - M1" | Granel | 2,25 € |
| RA-482.0.00 | H3/4" - M1.1/4" | Granel | 10,00 € |
| RA-492.0.00 | H3/4" - M1.1/2" | Granel | 6,36 € |
| RA-490.0.00 | H1" - M1.1/4" | Granel | 3,80 € |
| RA-493.0.00 | H1" - M1.1/2" | Granel | 6,54 € |
| RA-494.0.00 | H1.1/4" - M1.1/2" | Granel | 4,64 € |
| RA-495.0.00 | H1" - M2" | Granel | 9,24 € |
| RA-496.0.00 | H1.1/4" - M2" | Granel | 8,96 € |
| RA-497.0.00 | H1.1/2" - M2" | Granel | 7,48 € |
| RA-498.0.00 | H2" - M2.1/2" | Granel | 19,24 € |
| RA-499.0.00 | H2" - M3" | Granel | 28,08 € |
| RA-502.0.00 | H2.1/2" - M3" | Granel | 25,24 € |

▼ LATÓN:

| Referencia | Medida | Embalaje | Precio |
|-------------|-------------|----------|--------|
| RA-500.0.00 | M1" - H1/2" | Granel | 3,04 € |

▼ CROMADO:

| Referencia | Medida | Embalaje | Precio |
|-------------|---------------|----------------------|--------|
| RA-461.0.00 | H3/8" - M1/2" | Granel | 2,68 € |
| RA-461.6.00 | | Bolsa solapa (2 und) | 6,56 € |
| RA-471.0.00 | H1/2" - M3/4" | Granel | 2,42 € |
| RA-471.6.00 | | Bolsa solapa (2 und) | 6,05 € |
| RA-481.0.00 | H3/4" - M1" | Granel | 3,75 € |
| RA-491.0.00 | H1" - M1.1/4" | Granel | 4,42 € |
| RA-501.0.00 | H1/2" - M1" | Granel | 4,43 € |

REDUCCIÓN LISA



▼ LATÓN:

| Referencia | Medida | Embalaje | Precio |
|-------------|-------------|----------|--------|
| RA-510.0.00 | 1/2" - 3/8" | Granel | 1,58 € |
| RA-520.0.00 | 3/4" - 1/2" | Granel | 2,76 € |

▼ CROMADO:

| Referencia | Rosca | Embalaje | Precio |
|-------------|-------------|----------|--------|
| RA-511.0.00 | 1/2" - 3/8" | Granel | 2,65 € |
| RA-521.0.00 | 3/4" - 1/2" | Granel | 2,86 € |

REDUCCIÓN ESPECIAL



▼ METÁLICO CROMADO:

| Referencia | Medida | Embalaje | Precio |
|-------------|-------------|----------|--------|
| RA-560.0.00 | M22" - M24" | Granel | 1,07 € |

▼ CROMADO:

| Referencia | Medida | Embalaje | Precio |
|-------------|--------------|----------|--------|
| RA-540.0.00 | H22" - M1/2" | Granel | 2,52 € |
| RA-550.0.00 | H1/2" - M22" | Granel | 3,47 € |

▼ PLÁSTICO

| Referencia | Medida | Embalaje | Precio |
|-------------|-------------|----------|--------|
| RA-561.0.00 | M22" - M24" | Granel | 0,27 € |

TAPÓN MACHO



▼ LATÓN:

| Referencia | Medida | Embalaje | Precio |
|-------------|--------|----------------------|---------|
| RA-570.0.00 | 3/8" | Granel | 1,02 € |
| RA-570.6.00 | | Bolsa solapa (2 und) | 3,24 € |
| RA-580.0.00 | 1/2" | Granel | 1,02 € |
| RA-580.6.00 | | Bolsa solapa (2 und) | 3,24 € |
| RA-600.0.00 | 3/4" | Granel | 1,69 € |
| RA-600.6.00 | | Bolsa solapa (2 und) | 4,58 € |
| RA-610.0.00 | 1" | Granel | 2,66 € |
| RA-612.0.00 | 1.1/4" | Granel | 4,00 € |
| RA-613.0.00 | 1.1/2" | Granel | 4,97 € |
| RA-614.0.00 | 2" | Granel | 8,08 € |
| RA-615.0.00 | 2.1/2" | Granel | 18,18 € |
| RA-616.0.00 | 3" | Granel | 24,44 € |

▼ CROMADO:

| Referencia | Medida | Embalaje | Precio |
|-------------|--------|----------------------|--------|
| RA-571.0.00 | 3/8" | Granel | 1,46 € |
| RA-571.6.00 | | Bolsa solapa (2 und) | 4,13 € |
| RA-581.0.00 | 1/2" | Granel | 1,57 € |
| RA-581.6.00 | | Bolsa solapa (2 und) | 4,33 € |
| RA-601.0.00 | 3/4" | Granel | 3,49 € |
| RA-601.6.00 | | Bolsa solapa (2 und) | 8,19 € |
| RA-611.0.00 | 1" | Granel | 3,87 € |

TAPÓN HEMBRA LATÓN



▼ LATÓN:

| Referencia | Medida | Embalaje | Precio |
|-------------|--------|----------------------|--------|
| RA-620.0.00 | 3/8" | Granel | 1,10 € |
| RA-620.6.00 | | Bolsa solapa (2 und) | 3,41 € |
| RA-630.0.00 | 1/2" | Granel | 1,05 € |
| RA-630.6.00 | | Bolsa solapa (2 und) | 3,30 € |
| RA-640.0.00 | 3/4" | Granel | 1,51 € |
| RA-640.6.00 | | Bolsa solapa (2 und) | 4,21 € |
| RA-650.0.00 | 1" | Granel | 2,56 € |
| RA-652.0.00 | 1.1/4" | Granel | 4,32 € |
| RA-653.0.00 | 1.1/2" | Granel | 5,78 € |
| RA-654.0.00 | 2" | Granel | 9,40 € |

▼ CROMADO:

| Referencia | Medida | Embalaje | Precio |
|-------------|--------|----------|--------|
| RA-621.0.00 | 3/8" | Granel | 1,51 € |
| RA-631.0.00 | 1/2" | Granel | 2,59 € |
| RA-641.0.00 | 3/4" | Granel | 2,09 € |
| RA-651.0.00 | 1" | Granel | 2,64 € |

MANGUITO



▼ LATÓN:

| Referencia | Medida | Embalaje | Precio |
|-------------|--------|--------------|---------|
| RA-690.0.00 | 1/2" | Granel | 2,39 € |
| RA-690.6.00 | | Bolsa Solapa | 3,59 € |
| RA-700.0.00 | 3/4" | Granel | 2,88 € |
| RA-700.6.00 | | Bolsa Solapa | 4,08 € |
| RA-710.0.00 | 1" | Granel | 4,40 € |
| RA-712.0.00 | 1.1/4" | Granel | 7,70 € |
| RA-713.0.00 | 1.1/2" | Granel | 9,36 € |
| RA-714.0.00 | 2" | Granel | 14,44 € |
| RA-715.0.00 | 2.1/2" | Granel | 20,40 € |
| RA-716.0.00 | 3" | Granel | 31,08 € |

▼ CROMADO:

| Referencia | Medida | Embalaje | Precio |
|-------------|--------|--------------|--------|
| RA-691.0.00 | 1/2" | Granel | 2,65 € |
| RA-691.6.00 | | Bolsa solapa | 3,85 € |
| RA-701.0.00 | 3/4" | Granel | 3,61 € |
| RA-701.6.00 | | Bolsa solapa | 4,81 € |
| RA-711.0.00 | 1" | Granel | 7,68 € |

TE



▼ LATÓN:

| Referencia | Medida | Embalaje | Precio |
|-------------|--------|--------------|---------|
| RA-720.0.00 | 1/2" | Granel | 3,87 € |
| RA-720.6.00 | | Bolsa solapa | 5,07 € |
| RA-730.0.00 | 3/4" | Granel | 5,51 € |
| RA-730.6.00 | | Bolsa solapa | 6,71 € |
| RA-740.0.00 | 1" | Granel | 8,44 € |
| RA-742.0.00 | 1.1/4" | Granel | 12,76 € |
| RA-743.0.00 | 1.1/2" | Granel | 17,20 € |
| RA-744.0.00 | 2" | Granel | 23,16 € |
| RA-745.0.00 | 2.1/2" | Granel | 41,08 € |
| RA-746.0.00 | 3" | Granel | 73,84 € |

▼ CROMADO:

| Referencia | Medida | Embalaje | Precio |
|-------------|--------|--------------|---------|
| RA-721.0.00 | 1/2" | Granel | 4,49 € |
| RA-721.6.00 | | Bolsa solapa | 5,69 € |
| RA-731.0.00 | 3/4" | Granel | 6,87 € |
| RA-731.6.00 | | Bolsa solapa | 8,07 € |
| RA-741.0.00 | 1" | Granel | 13,15 € |

CODO HH



▼ LATÓN:

| Referencia | Medida | Embalaje | Precio |
|-------------|--------|--------------|---------|
| RA-750.0.00 | 1/2" | Granel | 3,01 € |
| RA-750.2.00 | | Bolsa solapa | 4,21 € |
| RA-760.0.00 | 3/4" | Granel | 4,25 € |
| RA-760.2.00 | | Bolsa solapa | 5,45 € |
| RA-770.0.00 | 1" | Granel | 6,32 € |
| RA-772.0.00 | 1.1/4" | Granel | 10,20 € |
| RA-773.0.00 | 1.1/2" | Granel | 13,12 € |
| RA-774.0.00 | 2" | Granel | 20,68 € |
| RA-775.0.00 | 2.1/2" | Granel | 33,00 € |
| RA-776.0.00 | 3" | Granel | 55,48 € |

▼ CROMADO:

| Referencia | Medida | Embalaje | Precio |
|-------------|--------|--------------|---------|
| RA-751.0.00 | 1/2" | Granel | 6,30 € |
| RA-751.6.00 | | Bolsa solapa | 7,50 € |
| RA-761.0.00 | 3/4" | Granel | 4,58 € |
| RA-761.6.00 | | Bolsa solapa | 5,78 € |
| RA-771.0.00 | 1" | Granel | 10,20 € |

CODO MH



▼ LATÓN:

| Referencia | Medida | Embalaje | Precio |
|-------------|--------|--------------|---------|
| RA-780.0.00 | 1/2" | Granel | 3,06 € |
| RA-780.6.00 | | Bolsa solapa | 4,26 € |
| RA-790.0.00 | 3/4" | Granel | 4,16 € |
| RA-790.6.00 | | Bolsa solapa | 5,36 € |
| RA-800.0.00 | 1" | Granel | 5,86 € |
| RA-802.0.00 | 1.1/4" | Granel | 10,52 € |
| RA-803.0.00 | 1.1/2" | Granel | 11,72 € |
| RA-804.0.00 | 2" | Granel | 17,56 € |
| RA-805.0.00 | 2.1/2" | Granel | 39,80 € |
| RA-806.0.00 | 3" | Granel | 71,24 € |

▼ CROMADO:

| Referencia | Medida | Embalaje | Precio |
|-------------|--------|--------------|--------|
| RA-781.0.00 | 1/2" | Granel | 5,22 € |
| RA-781.6.00 | | Bolsa solapa | 6,42 € |
| RA-791.0.00 | 3/4" | Granel | 3,96 € |
| RA-791.6.00 | | Bolsa solapa | 5,16 € |
| RA-801.0.00 | 1" | Granel | 9,52 € |

ALARGO GRIFO LATÓN



▼ LATÓN:

| Referencia | Medida | Embalaje | Precio |
|-------------|---------------|----------------------|---------|
| RA-160.0.00 | | Granel | 6,03 € |
| RA-160.6.00 | 1/2" x 3 cm. | Bolsa solapa (2 und) | 13,26 € |
| RA-170.0.00 | | Granel | 4,08 € |
| RA-170.6.00 | 1/2" x 5 cm. | Bolsa solapa (2 und) | 10,16 € |
| RA-190.0.00 | | Granel | 7,88 € |
| RA-190.6.00 | 1/2" x 10 cm. | Bolsa solapa (2 und) | 17,76 € |
| RA-200.0.00 | | Granel | 7,76 € |
| RA-200.6.00 | 3/4" x 3 cm. | Bolsa solapa (2 und) | 17,52 € |
| RA-210.0.00 | | Granel | 8,52 € |
| RA-210.6.00 | 3/4" x 5 cm. | Bolsa solapa (2 und) | 19,04 € |
| RA-230.0.00 | | Granel | 15,60 € |
| RA-230.6.00 | 3/4" x 10 cm. | Bolsa solapa (2 und) | 33,20 € |

▼ CROMADO:

| Referencia | Medida | Embalaje | Precio |
|-------------|---------------|----------------------|---------|
| RA-080.0.00 | | Granel | 6,60 € |
| RA-080.6.00 | 1/2" x 3 cm. | Bolsa solapa (2 und) | 15,20 € |
| RA-090.0.00 | | Granel | 9,99 € |
| RA-090.6.00 | 1/2" x 5 cm. | Bolsa solapa (2 und) | 18,08 € |
| RA-100.0.00 | 1/2" x 8 cm. | Granel | 11,35 € |
| RA-110.0.00 | | Granel | 19,64 € |
| RA-110.6.00 | 1/2" x 10 cm. | Bolsa solapa (2 und) | 41,28 € |
| RA-120.0.00 | | Granel | 4,24 € |
| RA-120.6.00 | 3/4" x 3 cm. | Bolsa solapa (2 und) | 10,48 € |
| RA-130.0.00 | | Granel | 16,36 € |
| RA-130.6.00 | 3/4" x 5 cm. | Bolsa solapa (2 und) | 34,72 € |
| RA-150.0.00 | | Granel | 19,44 € |
| RA-150.6.00 | 3/4" x 10 cm. | Bolsa solapa (2 und) | 40,88 € |

CONTRARROSCA LATÓN

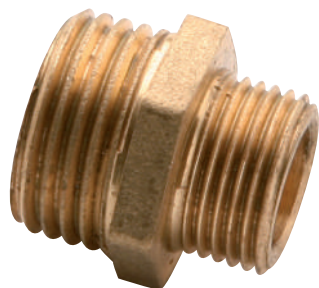

▼ LATÓN:

| Referencia | Medida | Embalaje | Precio |
|-------------|-----------------|--------------|---------|
| RA-240.0.00 | | Granel | 1,07 € |
| RA-240.6.00 | 3/8" x 3/8" | Bolsa solapa | 3,34 € |
| RA-250.0.00 | | Granel | 1,35 € |
| RA-250.6.00 | 3/8" x 1/2" | Bolsa solapa | 3,89 € |
| RA-260.0.00 | | Granel | 1,51 € |
| RA-260.6.00 | 1/2" x 1/2" | Bolsa solapa | 4,21 € |
| RA-290.0.00 | | Granel | 2,04 € |
| RA-290.6.00 | 1/2" x 3/4" | Bolsa solapa | 5,28 € |
| RA-280.0.00 | | Granel | 1,91 € |
| RA-280.6.00 | 3/4" x 3/4" | Bolsa solapa | 5,01 € |
| RA-320.0.00 | 3/4" x 1" | Granel | 3,11 € |
| RA-300.0.00 | 1" x 1" | Granel | 3,20 € |
| RA-322.0.00 | 1.1/4" x 1" | Granel | 5,20 € |
| RA-302.0.00 | 1.1/4" x 1.1/4" | Granel | 5,12 € |
| RA-310.0.00 | 1/2" x 1" | Granel | 4,80 € |
| RA-323.0.00 | 1.1/2" x 1.1/4" | Granel | 8,04 € |
| RA-303.0.00 | 1.1/2" x 1.1/2" | Granel | 6,88 € |
| RA-324.0.00 | 2" x 1.1/2" | Granel | 10,68 € |
| RA-304.0.00 | 2" x 2" | Granel | 9,76 € |
| RA-325.0.00 | 2.1/2" x 2" | Granel | 18,08 € |
| RA-305.0.00 | 2.1/2" x 2.1/2" | Granel | 19,52 € |
| RA-306.0.00 | 3" x 3" | Granel | 25,88 € |

▼ CROMADO:

| Referencia | Medida | Embalaje | Precio |
|-------------|-------------|--------------|--------|
| RA-241.0.00 | | Granel | 1,95 € |
| RA-241.6.00 | 3/8" x 3/8" | Bolsa solapa | 5,10 € |
| RA-251.0.00 | | Granel | 2,59 € |
| RA-251.6.00 | 3/8" x 1/2" | Bolsa solapa | 6,38 € |
| RA-261.0.00 | | Granel | 2,78 € |
| RA-261.6.00 | 1/2" x 1/2" | Bolsa solapa | 6,77 € |
| RA-281.0.00 | | Granel | 3,76 € |
| RA-281.6.00 | 3/4" x 3/4" | Bolsa solapa | 8,73 € |
| RA-291.0.00 | | Granel | 4,08 € |
| RA-291.6.00 | 1/2" x 3/4" | Bolsa solapa | 9,36 € |
| RA-301.0.00 | 1" x 1" | Granel | 4,91 € |
| RA-311.0.00 | 1/2" x 1" | Granel | 3,36 € |
| RA-321.0.00 | 3/4" x 1" | Granel | 1,23 € |



PELUQUERÍA

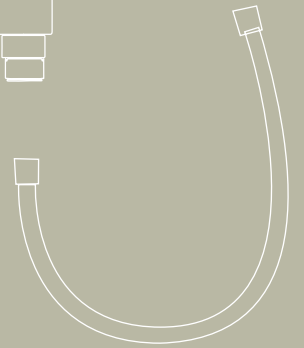
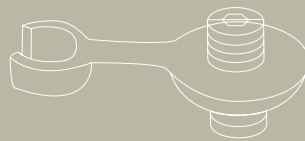
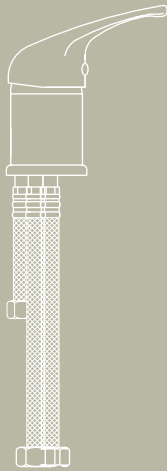

CON MANGO EXTRAÍBLE



| Referencia | Precio |
|------------|----------|
| PL-36.5.00 | 122,80 € |

ESTÁNDAR



| Referencia | Precio |
|-------------|---------|
| PL-010.5.00 | 66,69 € |

OVALADO



| Referencia | Precio |
|-------------|---------|
| PL-110.5.00 | 75,48 € |

MINIMALISTA



| Referencia | Precio |
|-------------|---------|
| PL-100.5.00 | 55,27 € |

MINIMALISTA PALA



| Referencia | Precio |
|--------------|---------|
| PL-0331.5.00 | 85,04 € |

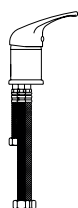

CONEXIONES DE ALIMENTACIÓN INCLUIDAS.

Entrada agua caliente, entrada agua fría y salida para el mango lavacabezas.

| | |
|----------|-------------|
| Entradas | 60 cm. H3/8 |
| Salida | 30 cm. H3/8 |

ROSCA MACHO 3/8"



| Referencia | Acabado | Precio |
|------------|---------|---------|
| PL-14.7.00 | Cromado | 12,46 € |
| PL-10.7.00 | Negro | 12,04 € |

ROSCA HEMBRA 15/100



| Referencia | Acabado | Precio |
|------------|---------|---------|
| PL-11.7.00 | Cromado | 16,64 € |
| PL-13.7.00 | Negro | 14,68 € |

PELUQUERÍA - Soportes

GRANDE



| Referencia | Precio |
|------------|--------|
| PL-12.7.00 | 4,06 € |

PEQUEÑO



| Referencia | Precio |
|------------|--------|
| PL-17.7.00 | 4,22 € |

OLD FASHION



| Referencia | Precio |
|------------|--------|
| PL-15.7.00 | 6,15 € |

ANTI-GOTEO



- Instalable en las cerámicas.
- Evitando la caída de gotas al suelo.
- Metálico.

| Referencia | Precio |
|------------|---------|
| PL-23.7.00 | 15,42 € |



PVC CROMADO



| Referencia | Rosca | Precio |
|-------------|--------------|---------|
| PL-057.0.00 | Macho 15/100 | 11,48 € |
| PL-06.0.00 | Hembra 3/8" | 83,73€ |

PVC GRIS



| Referencia | Rosca | Precio |
|-------------|--------------|--------|
| PL-056.0.00 | Macho 15/100 | 7,97 € |
| PL-04.0.00 | Hembra 3/8" | 5,28 € |

1,25 m.

PVC NEGRO



| Referencia | Rosca | Precio |
|-------------|--------------|--------|
| PL-058.0.00 | Macho 15/100 | 6,92 € |
| PL-05.0.00 | Hembra 3/8" | 4,47 € |

POLIMÉRICO NEGRO



| Referencia | Rosca | Precio |
|-------------|--------------|--------|
| PL-055.0.00 | Macho 15/100 | 7,26 € |
| PL-053.0.00 | Hembra 3/8" | 5,58 € |

Diagrama de Compatibilidades

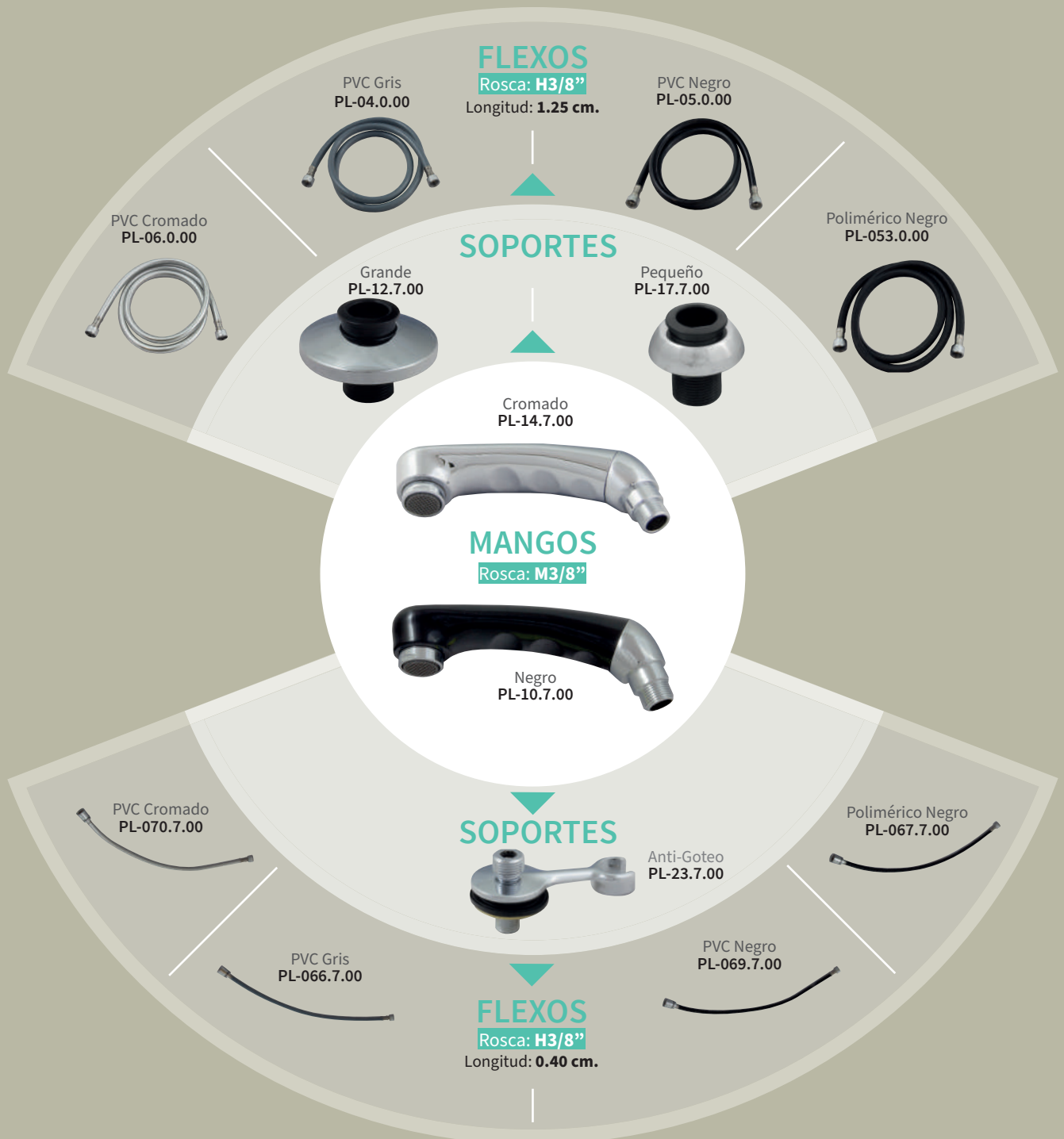
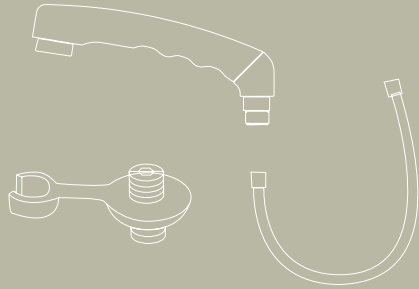

Cree su propia
combinación

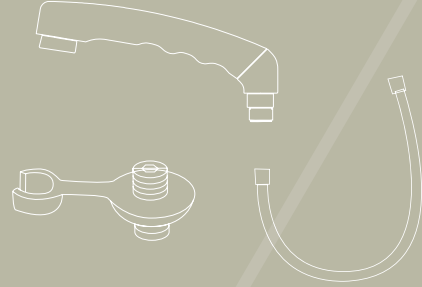

FLEXOS

Rosca: M3/8"
Longitud: 1.25 cm.

PVC Gris
PL-056.7.00



PVC Negro
PL-058.7.00



PVC Cromado
PL-057.0.00



Polimérico Negro
PL-055.0.00



SOPORTES

Old fashion
PL-15.7.00



Cromado
PL-11.7.00



MANGOS

Rosca: H3/8"

Negro
PL-13.7.00

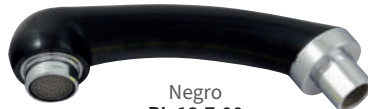

SOPORTES

Anti-Goteo
PL-23.7.00



PVC Cromado
PL-060.7.00



Polimérico Negro
PL-064.7.00



PVC Gris
PL-063.7.00

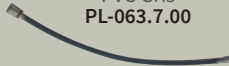

PVC Negro
PL-065.7.00

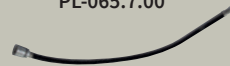

FLEXOS

Rosca: M3/8"
Longitud: 0.40 cm.



PVC CROMADO



| Referencia | Rosca | Precio |
|-------------|--------------|---------|
| PL-060.7.00 | Macho 15/100 | 11,56 € |
| PL-070.7.00 | Hembra 3/8" | 10,58 € |

PVC GRIS



| Referencia | Rosca | Precio |
|-------------|--------------|--------|
| PL-063.7.00 | Macho 15/100 | 7,92 € |
| PL-066.7.00 | Hembra 3/8" | 7,14 € |

0,40 m.

PVC NEGRO



| Referencia | Rosca | Precio |
|-------------|--------------|--------|
| PL-065.7.00 | Macho 15/100 | 7,22 € |
| PL-069.7.00 | Hembra 3/8" | 6,77 € |

POLIMÉRICO NEGRO



| Referencia | Rosca | Precio |
|-------------|--------------|--------|
| PL-064.7.00 | Macho 15/100 | 8,61 € |
| PL-067.7.00 | Hembra 3/8" | 9,31 € |

CLIC-CLAC

- Seta cromada
- Universal
- Ø 60 mm.



| Referencia | Precio |
|-------------|---------|
| AF-335.5.00 | 15,82 € |

CLIC-CLAC PORCELANA BLANCA

- Seta de porcelana blanca
- Cromada
- Universal
- Ø 60 mm.



| Referencia | Precio |
|-------------|---------|
| AF-345.5.00 | 19,11 € |

SIFÓN EXTENSIBLE

- Diámetro: 32/40
- Medida: 30 a 80 cm.



| Referencia | Precio |
|------------|--------|
| PL-25.7.00 | 2,17 € |

TAPA ATRAPA PELOS

- Evita que el pelo vaya al desagüe.
- Fácil extracción para vertido en la papelera.



| Referencia | Precio |
|------------|--------|
| PL-60.7.00 | 3,85 € |

BASCULANTE PARA LAVACABEZAS

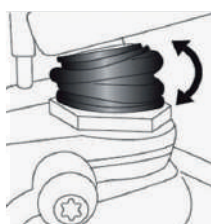
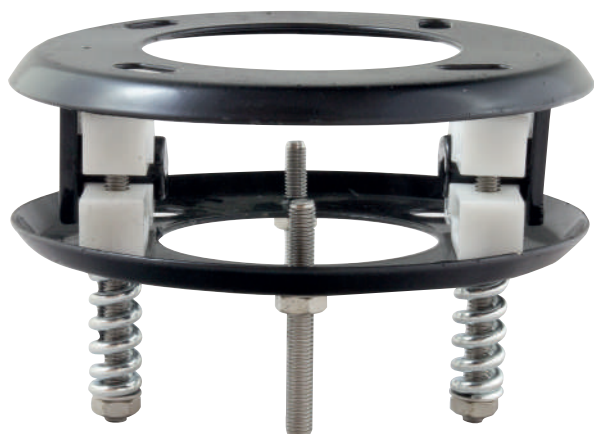

Permite el basculado del cuerpo del lavacabezas para acomodarlo a la posición del usuario.

Fuelle de goma negro incluido



| Referencia | Diametro | Precio |
|------------|----------|---------|
| PL-58.5.00 | 18,5 cm. | 32,55 € |
| PL-57.5.00 | 21 cm. | 33,18 € |

PROTECTOR NUCA

- Funda protectora lavacabezas.
- Fabricado con mezcla de siliconas para su perfecta adaptación.

| Referencia | Medida | Precio |
|------------|--------|---------|
| PL-29.7.00 | 20 cm. | 15,58 € |
| PL-28.7.00 | 13 cm. | 10,42 € |





GRIFERÍA INDUSTRIAL

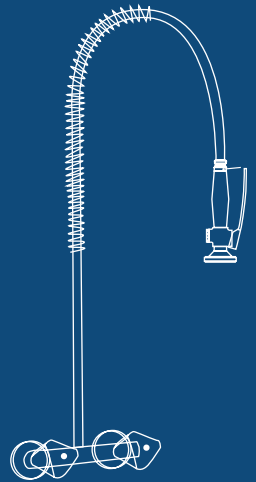
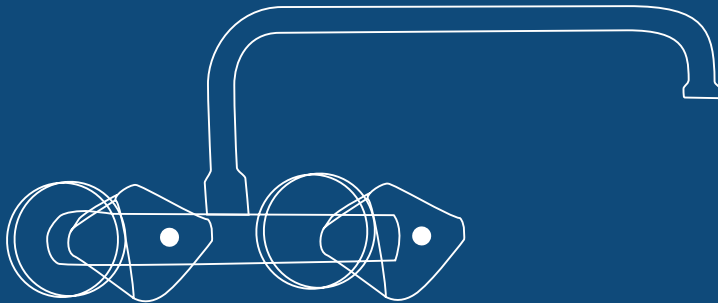
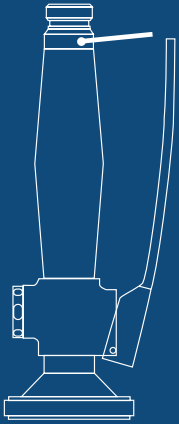

GRIFERÍA INDUSTRIAL

Para uso industrial alimentario en cocinas profesionales como hoteles, restaurantes, pescaderías, campings...

Múltiples combinaciones, posibilidad de sustituir o agregar elementos con facilidad, **Elementos combinables entre sí**, Adaptable para todo tipo de cocinas profesionales.

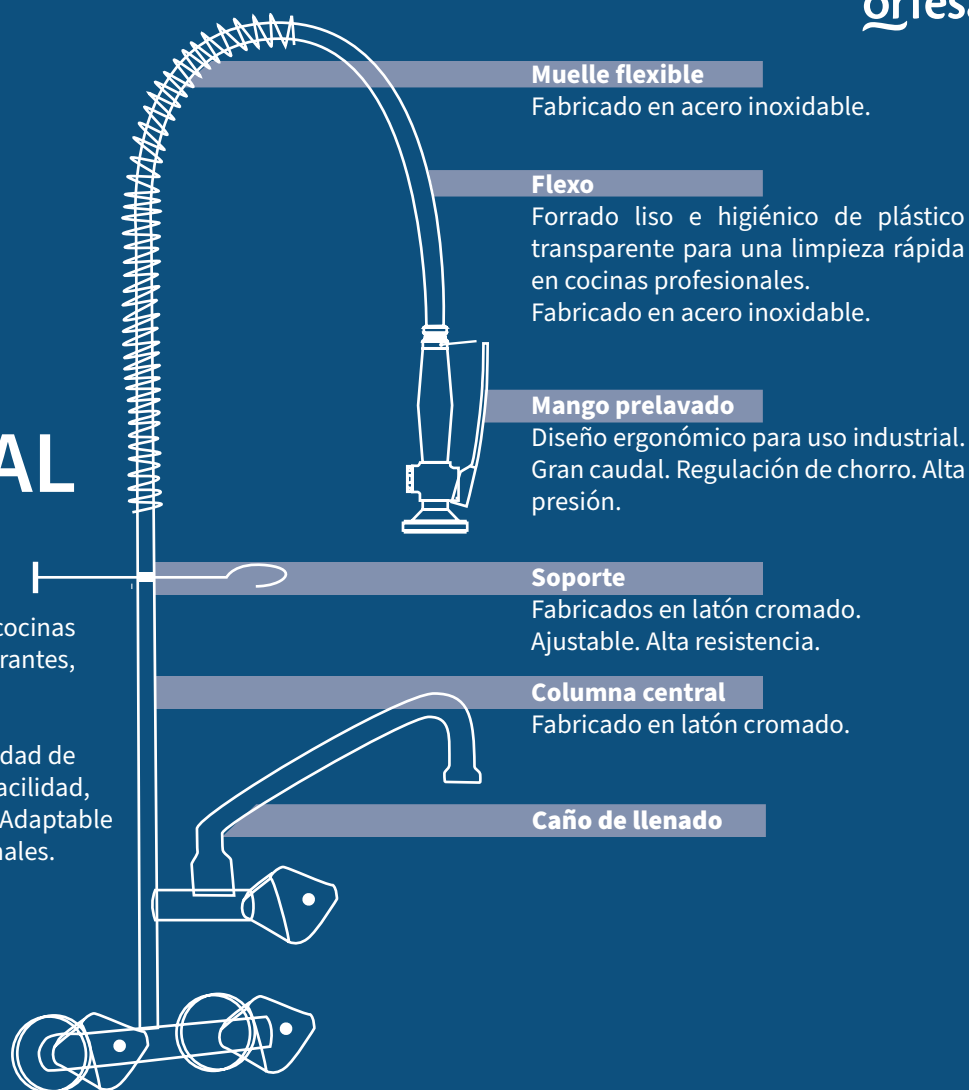

1 AGUA

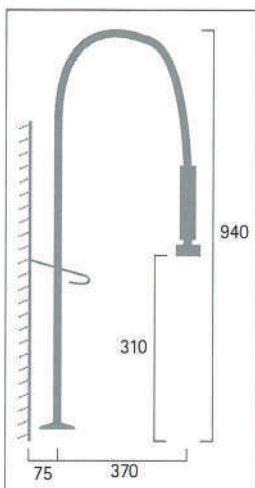

- Estanqueidad absoluta.
- Alta resistencia a la temperatura (110°).
- Presión de trabajo 20 kg.
- Montura cerámica de 1/4 de vuelta.
- Cromado de alta calidad.
- Tubo flexible de caucho sintético EP-DM, revestido con hilo de acero inoxidable trenzado AISI 304 plastificado.
- Muelle helicoidal de acero inoxidable.
- Gancho sujeción grifo pistola de acero inoxidable AISI 304.
- Caños giratorios.
- Soporte de sujeción a la pared regulable.
- Posición de salida de agua continua.

| Descripción | Referencia | Precio |
|------------------|------------|----------|
| 1 agua | DA0001 | 309,96 € |
| 1 agua con grifo | DA0003 | 325 € |
| 1 agua con caño | DA0004 | 444,60 € |

MONOMANDO

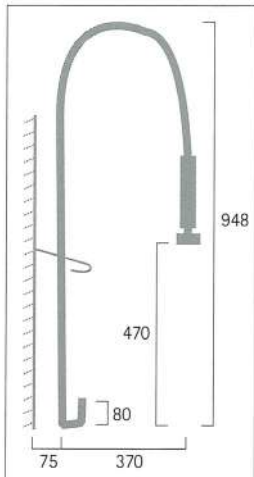

- Estanqueidad absoluta.
- Alta resistencia a la temperatura (110°).
- Presión de trabajo 20 kg.
- Montura cerámica de 1/4 de vuelta.
- Cromado de alta calidad.
- Tubo flexible de caucho sintético EP-DM, revestido con hilo de acero inoxidable trenzado AISI 304 plastificado.
- Muelle helicoidal de acero inoxidable.
- Gancho sujeción grifo pistola de acero inoxidable AISI 304.
- Caños giratorios.
- Soporte de sujeción a la pared regulable.
- Posición de salida de agua continua.

| Descripción | Referencia | Precio |
|----------------------------|------------|----------|
| Monomando | DM0003 | 336,22 € |
| Monomando maneta sanitaria | DM2003 | 350,28 € |

MONOMANDO CON CAÑO

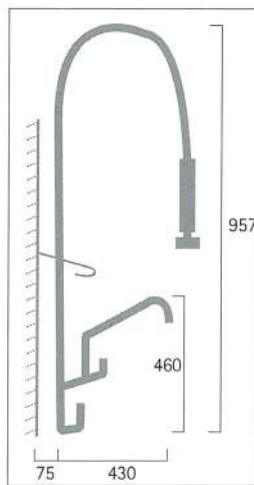

- Estanqueidad absoluta.
- Alta resistencia a la temperatura (110°).
- Presión de trabajo 20 kg.
- Montura cerámica de 1/4 de vuelta.
- Cromado de alta calidad.
- Tubo flexible de caucho sintético EP-DM, revestido con hilo de acero inoxidable trenzado AISI 304 plastificado.
- Muelle helicoidal de acero inoxidable.
- Gancho sujeción grifo pistola de acero inoxidable AISI 304.
- Caños giratorios.
- Soporte de sujeción a la pared regulable.
- Posición de salida de agua continua.

| Referencia | Precio |
|------------|----------|
| DM0005 | 522,24 € |

MONOMANDO MURAL

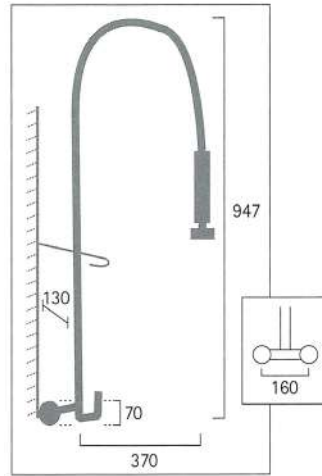

- Estanqueidad absoluta.
- Alta resistencia a la temperatura (110°).
- Presión de trabajo 20 kg.
- Montura cerámica de 1/4 de vuelta.
- Cromado de alta calidad.
- Tubo flexible de caucho sintético EP-DM, revestido con hilo de acero inoxidable trenzado AISI 304 plastificado.
- Muelle helicoidal de acero inoxidable.
- Gancho sujeción grifo pistola de acero inoxidable AISI 304.
- Caños giratorios.
- Soporte de sujeción a la pared regulable.
- Posición de salida de agua continua.

| Referencia | Precio |
|------------|--------|
| DU0004 | 318 € |

MONOMANDO MURAL CON CAÑO

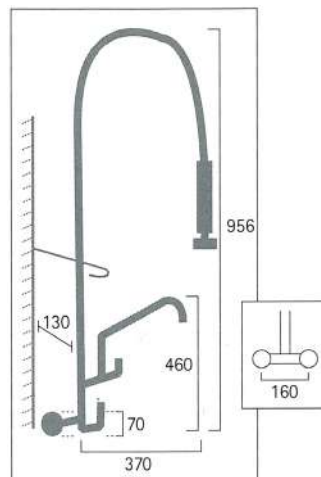

- Estanqueidad absoluta.
- Alta resistencia a la temperatura (110°).
- Presión de trabajo 20 kg.
- Montura cerámica de 1/4 de vuelta.
- Cromado de alta calidad.
- Tubo flexible de caucho sintético EP-DM, revestido con hilo de acero inoxidable trenzado AISI 304 plastificado.
- Muelle helicoidal de acero inoxidable.
- Gancho sujeción grifo pistola de acero inoxidable AISI 304.
- Caños giratorios.
- Soporte de sujeción a la pared regulable.
- Posición de salida de agua continua.

| Referencia | Precio |
|------------|----------|
| DU0006 | 608,92 € |

BATERÍA MURAL

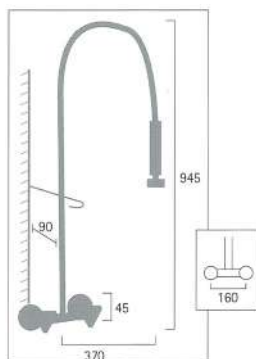

- Estanqueidad absoluta.
- Alta resistencia a la temperatura (110°).
- Presión de trabajo 20 kg.
- Montura cerámica de 1/4 de vuelta.
- Cromado de alta calidad.
- Tubo flexible de caucho sintético EP-DM, revestido con hilo de acero inoxidable trenzado AISI 304 plastificado.
- Muelle helicoidal de acero inoxidable.
- Gancho sujeción grifo pistola de acero inoxidable AISI 304.
- Caños giratorios.
- Soporte de sujeción a la pared regulable.
- Posición de salida de agua continua.

| Referencia | Precio |
|------------|----------|
| DB0004 | 230,24 € |

BATERÍA MURAL CON CAÑO

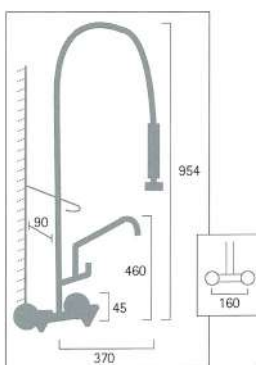

- Estanqueidad absoluta.
- Alta resistencia a la temperatura (110°).
- Presión de trabajo 20 kg.
- Montura cerámica de 1/4 de vuelta.
- Cromado de alta calidad.
- Tubo flexible de caucho sintético EP-DM, revestido con hilo de acero inoxidable trenzado AISI 304 plastificado.
- Muelle helicoidal de acero inoxidable.
- Gancho sujeción grifo pistola de acero inoxidable AISI 304.
- Caños giratorios.
- Soporte de sujeción a la pared regulable.
- Posición de salida de agua continua.

| Referencia | Precio |
|------------|----------|
| DB0006 | 682,56 € |

MONOMANDO BAR



- Caño giratorio.
- Cartucho cerámico para monomando.

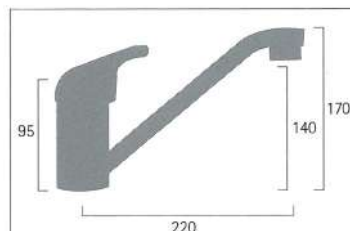

| Descripción | Referencia | Precio |
|------------------------------------|------------|---------|
| Monomando bar | GM0018 | 76,40 € |
| Monomando bar con maneta sanitaria | GM0218 | 51,32 € |

MONOMANDO OFFICE

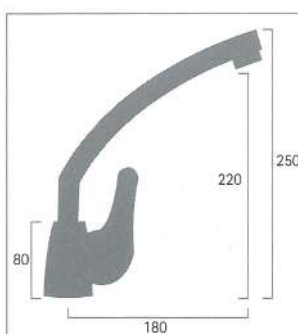

- Caño giratorio.
- Cartucho cerámico para monomando.

| Descripción | Referencia | Precio |
|------------------|------------|---------|
| Monomando office | GM0019 | 68,68 € |

MONOMANDO EXTENSIBLE



- Caño giratorio.
- Cartucho cerámico para monomando.

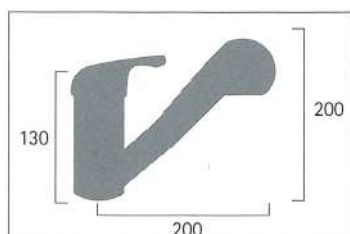

| Descripción | Referencia | Precio |
|----------------------|------------|---------|
| Monomando extensible | GM0020 | 93,92 € |

MONOMANDO CAÑO ALTO

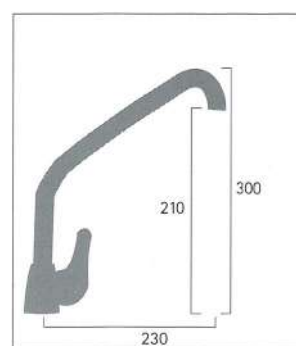
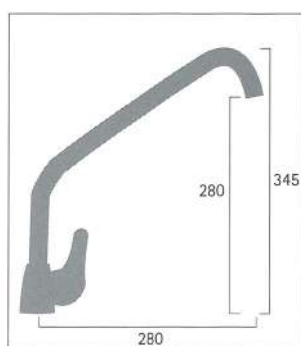

- Caño giratorio.
- Cartucho cerámico para monomando.

| Descripción | Altura | Referencia | Precio |
|--------------------------------|--------|------------|----------|
| Monomando | 26 cm. | GM2002 | 146,76 € |
| Monomando con maneta sanitaria | 26 cm. | GM2202 | 156,60 € |

MONOBLOC CAÑO ALTO



- Caño giratorio.
- Montura cerámica 1/4 de vuelta.
- Cartucho cerámico para monomando.

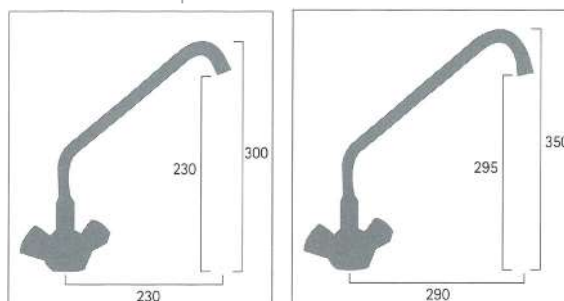

| Altura | Referencia | Precio |
|--------|------------|----------|
| 26 cm. | GE2002 | 131,48 € |

MONOMANDO MURAL CAÑO ALTO



- Caño giratorio.
- Cartucho cerámico para monomando.

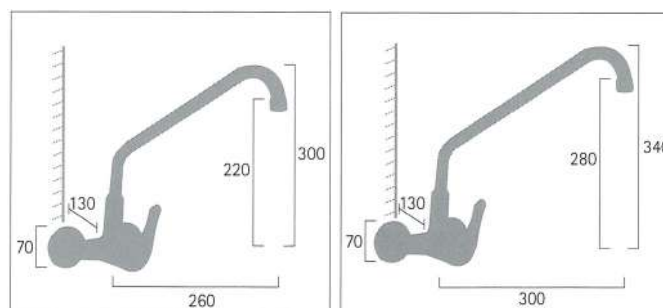

| Altura | Referencia | Precio |
|--------|------------|----------|
| 26 cm. | GU2002 | 126,12 € |

MONOMANDO MURAL CAÑO BAJO



- Caño giratorio.
- Cartucho cerámico para monomando.

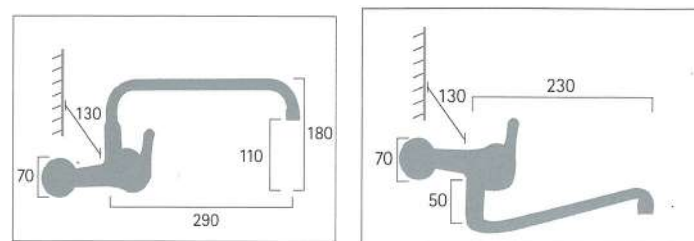

| Descripción | Altura | Referencia | Precio |
|------------------------------------|--------|------------|----------|
| Caño superior | 30 cm. | GU2004 | 148,64 € |
| Caño inferior con maneta sanitaria | 24 cm. | GU2205 | 120,96 € |

1 AGUA MURAL CAÑO ALTO



- Caño giratorio.
- Cartucho cerámico para monomando.

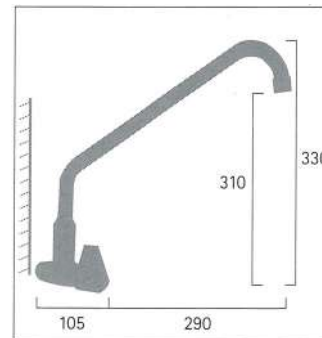
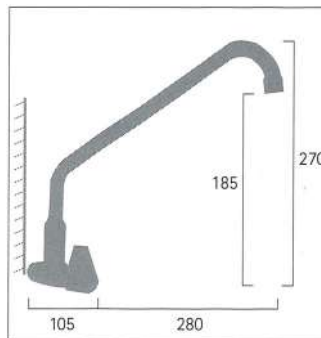

| Altura | Referencia | Precio |
|--------|------------|----------|
| 26 cm. | GA2002 | 101,96 € |

CAÑO ALTO GIRATORIO



- Caño giratorio.
- Cartucho cerámico para monomando.

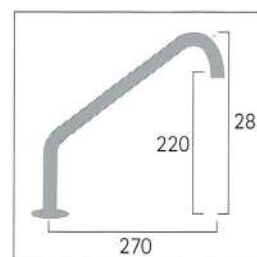
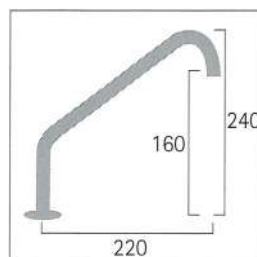

| Altura | Referencia | Precio |
|--------|------------|---------|
| 22 cm. | CL2003 | 99,60 € |
| 26 cm. | CL2002 | 69,96 € |

BASE SOPORTE 1 AGUA



| Referencia | Precio |
|------------|---------|
| BA0001 | 27,56 € |

BATERIA MURAL



| Referencia | Precio |
|------------|---------|
| SP0001 | 33,72 € |

MANETA MONOMANDO



| Referencia | Precio |
|------------|--------|
| MA0001 | 50 € |

PISTOLA GRIFO



- Rosca 1/2"
- Posición agua continua

| Referencia | Color | Precio |
|------------|-------|---------|
| PI0002 | Negro | 70,36 € |

FLEXO PLASTIFICADO



| Referencia | Medida | Precio |
|------------|---------|---------|
| FL0001 | 1,00 m. | 21,79 € |
| FL0002 | 1,25 m. | 22,93 € |
| FL0003 | 1,50 m. | 25,74 € |
| FL0004 | 1,80 m. | 28,34 € |
| FL0005 | 2,00 m. | 21,88 € |

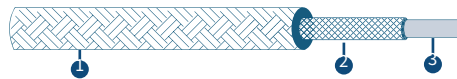

- 1 Revestimiento exterior en PVC UVI.
- 2 Revestimiento con hilo de acero inoxidable trenzado AISI 304 plastificado.
- 3 Tubo interior de caucho sintético EPDM atóxica.

MUELLE ACERO INOXIDABLE



| Referencia | Precio |
|------------|--------|
| LL0001 | 68 € |

MONTURA CERAMICA

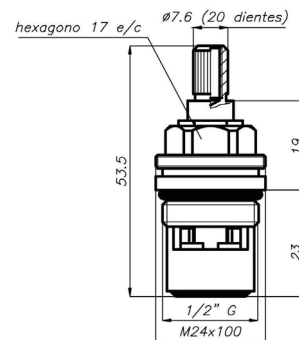

· 1/4 vuelta

| Referencia | Precio |
|------------|---------|
| RC0029 | 19,80 € |

CARTUCHO MONOMANDO



· Ø 40

| Referencia | Precio |
|------------|---------|
| RC0067 | 19,80 € |



orfesa

Barcelona - Spain

 (+34) 934 742 561

 orfesa@orfesa.net

 www.orfesa.net